

OBRA RECIENTE

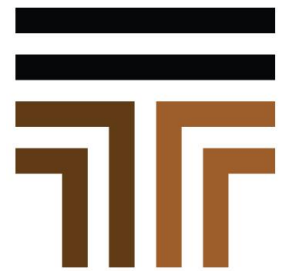

Tarimatec

TARIMAS SUELO















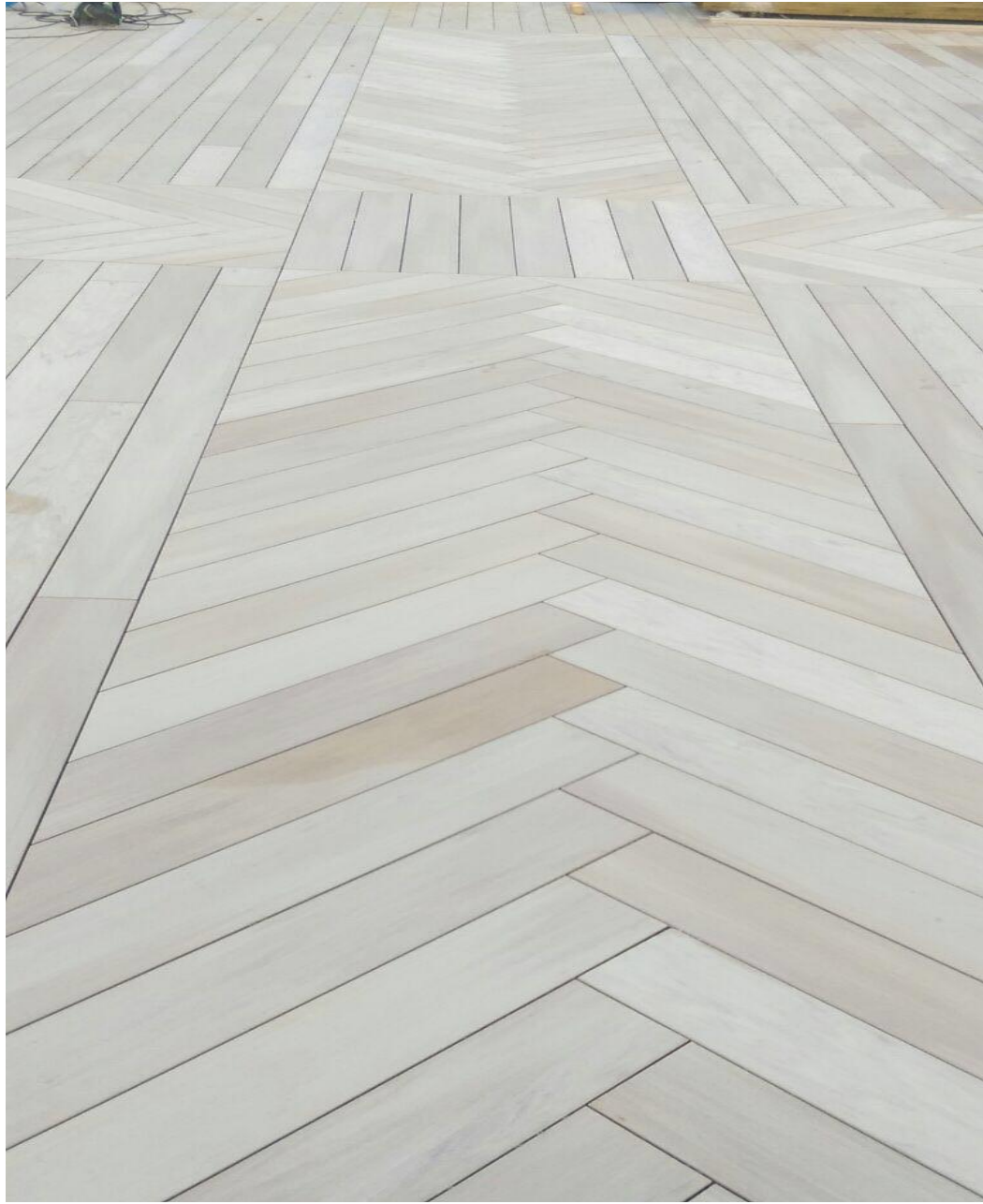











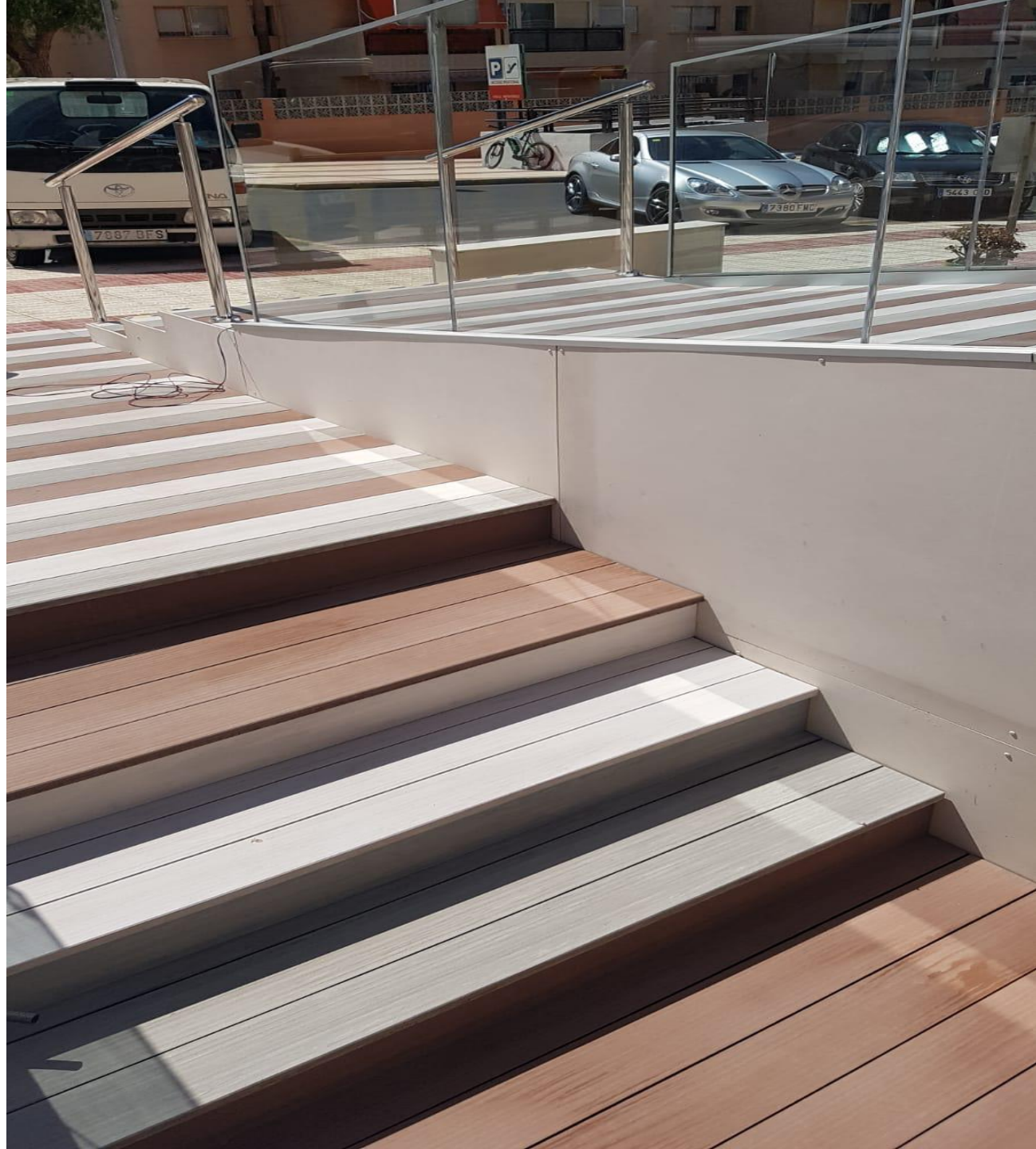

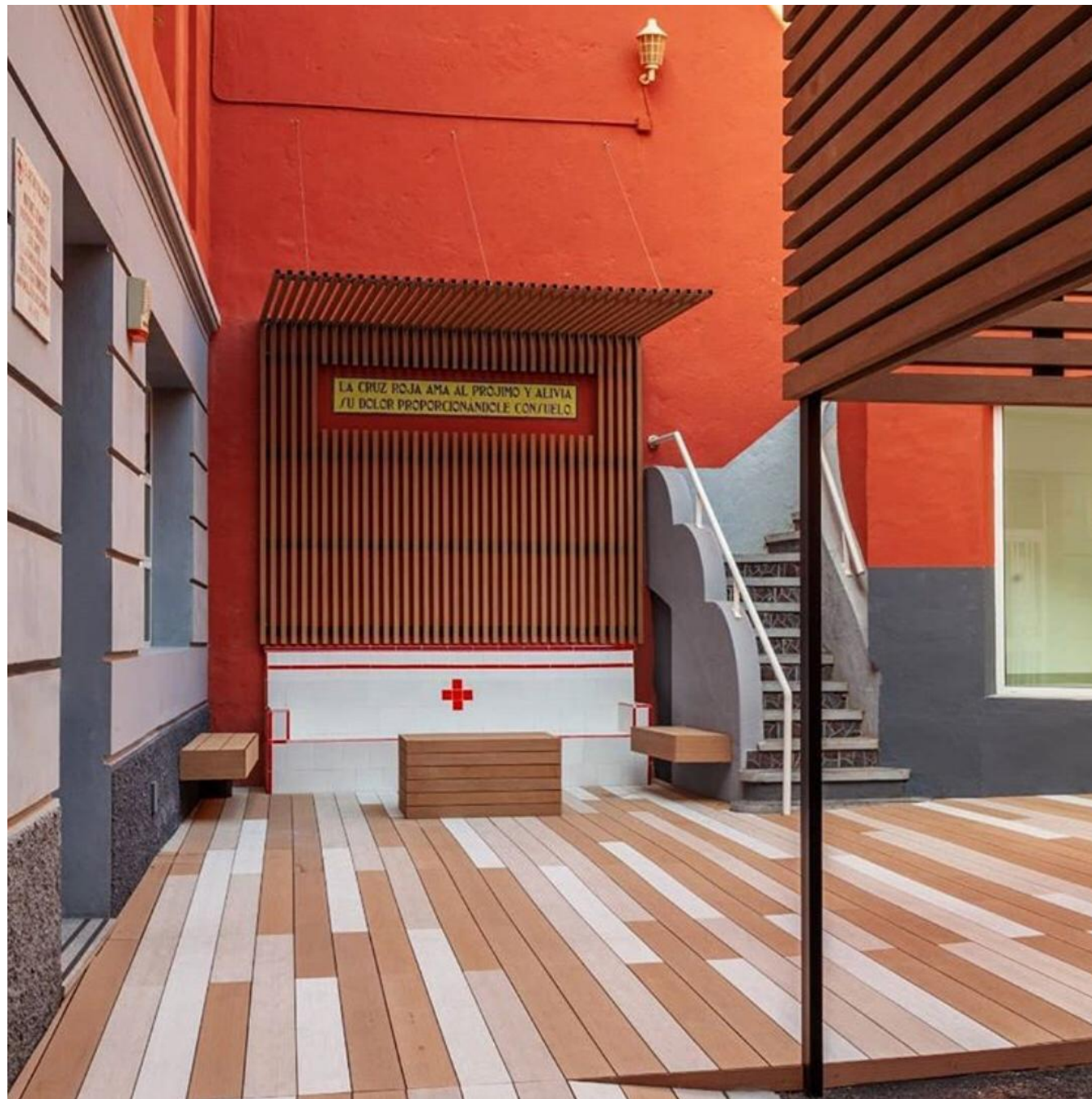



























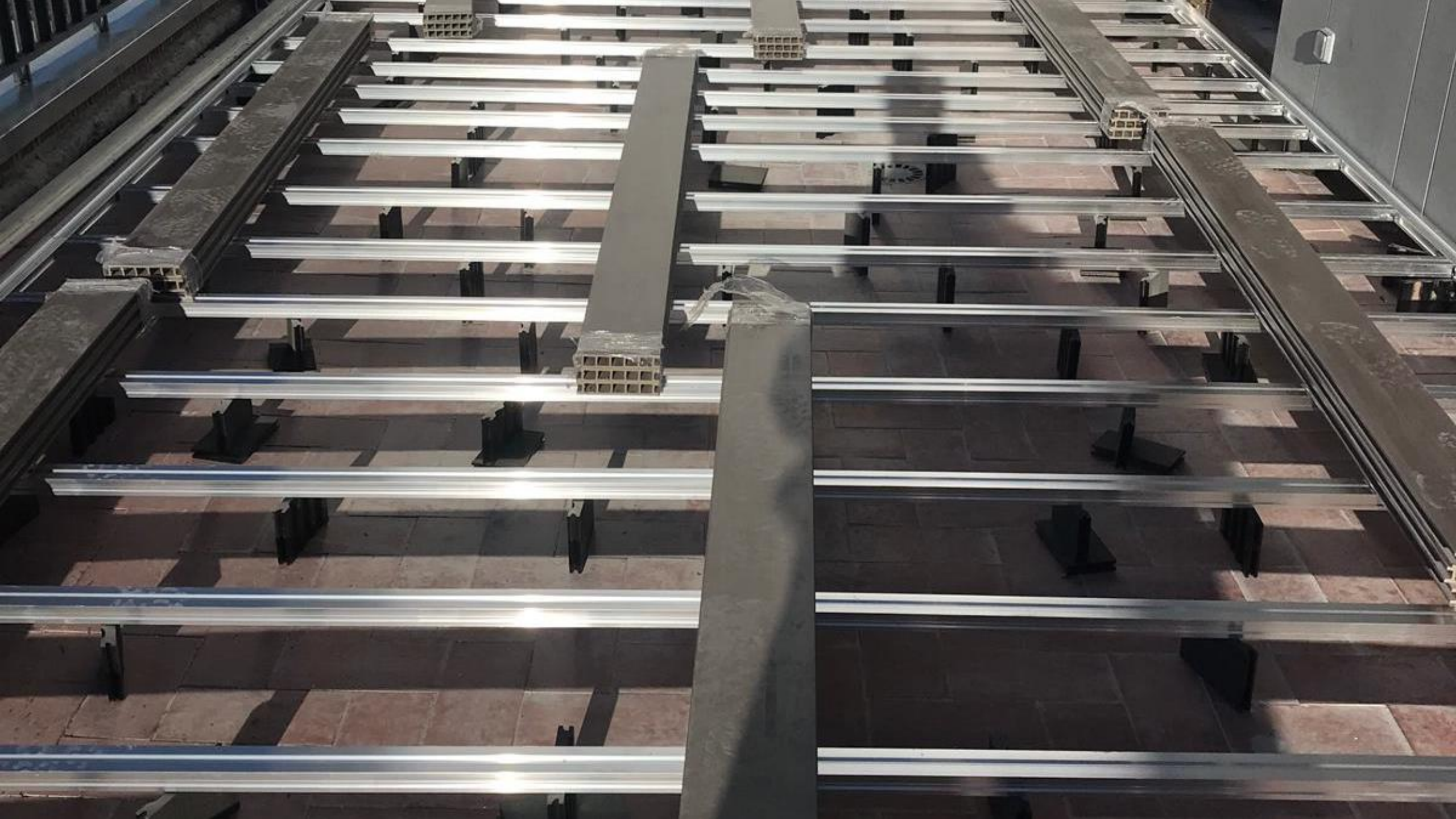







FACHADA VENTILADA



CINCO



FLORIDA
MONTANA



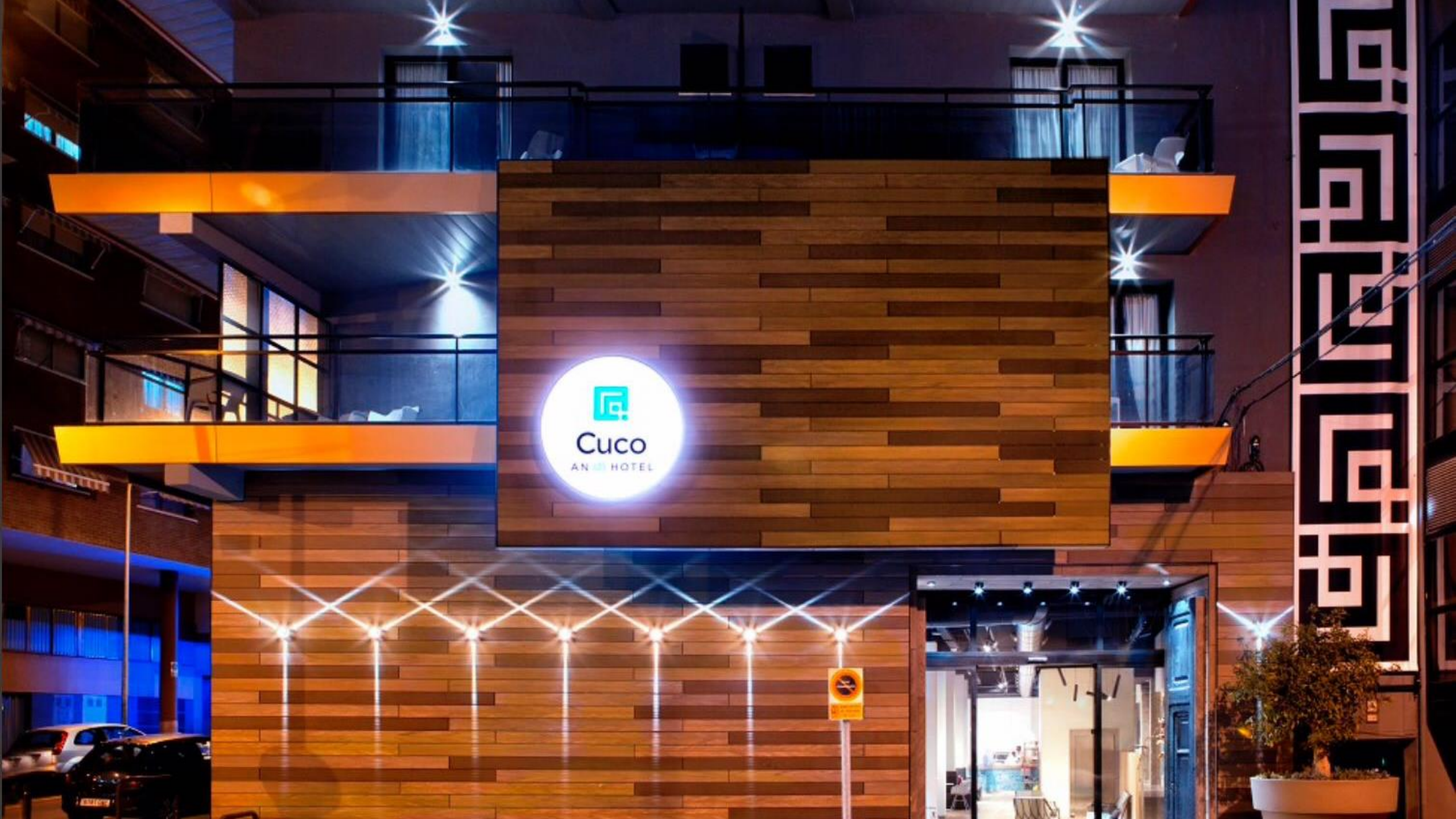

ALCUDIA PARK



IBEROSTAR



ALCUBIA PARK

XXXX

XXXX







 **FINESTRELL**

Media Markt

KIABI

 **Alcampo**

MANGO

Bershka

PULL&BEAR

OYSHO

 Stradivarius

ZARA

(Sfera)

NEW YORKER

DECATHLON

H&M



















SISTEMA ANNAPURNA







9540



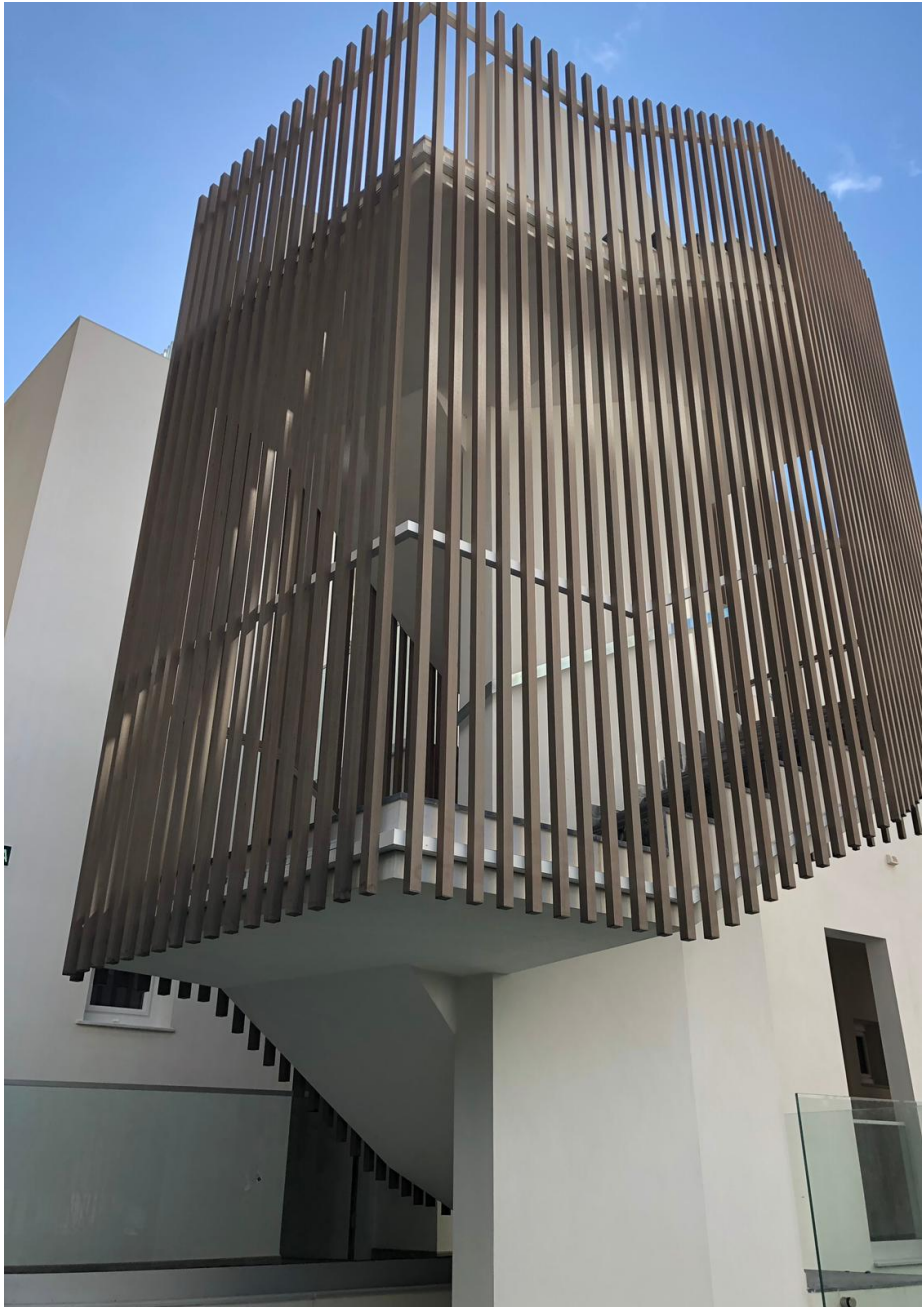















RHH | BAYREN^{****}
HOTEL & SPA









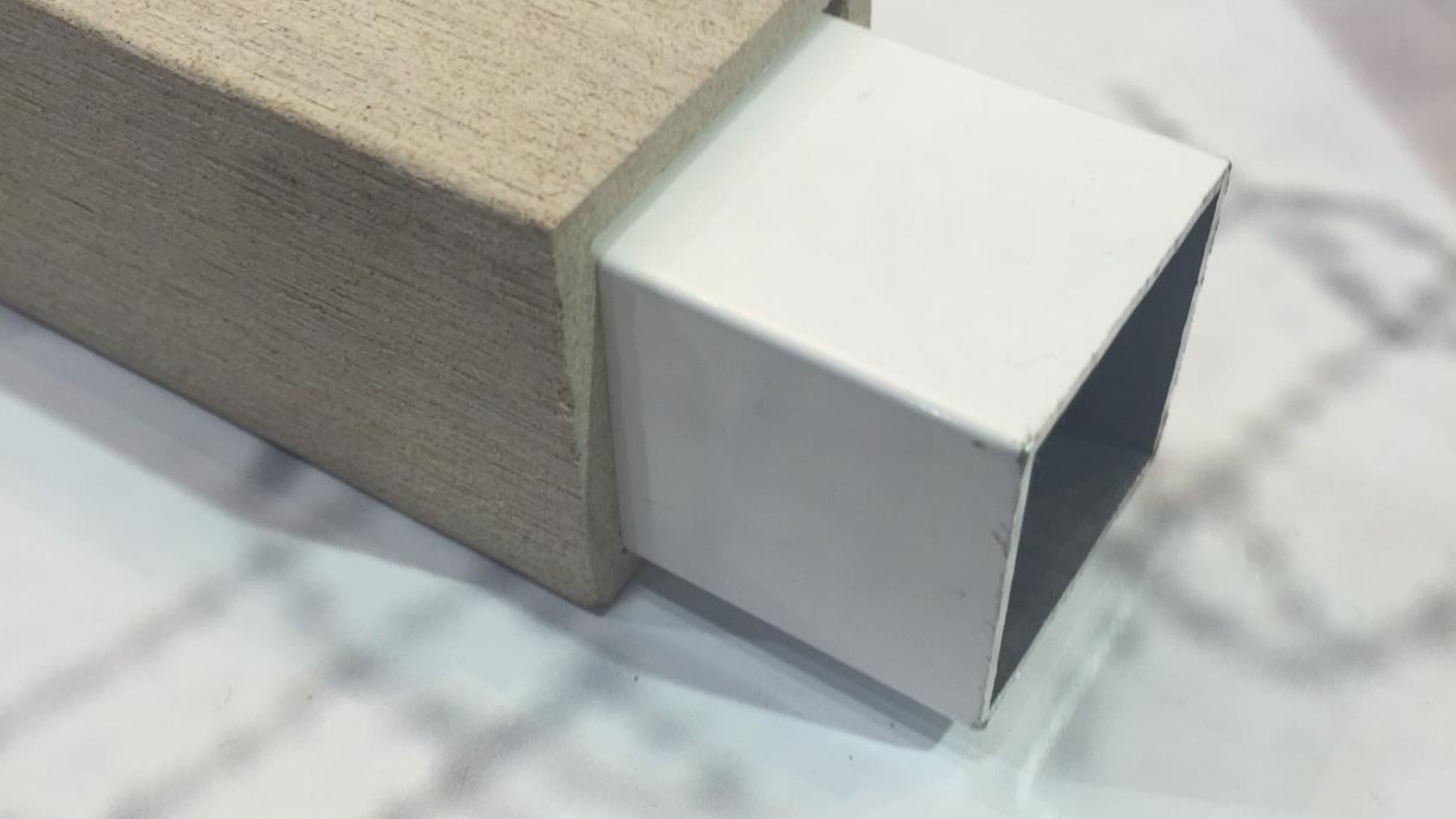



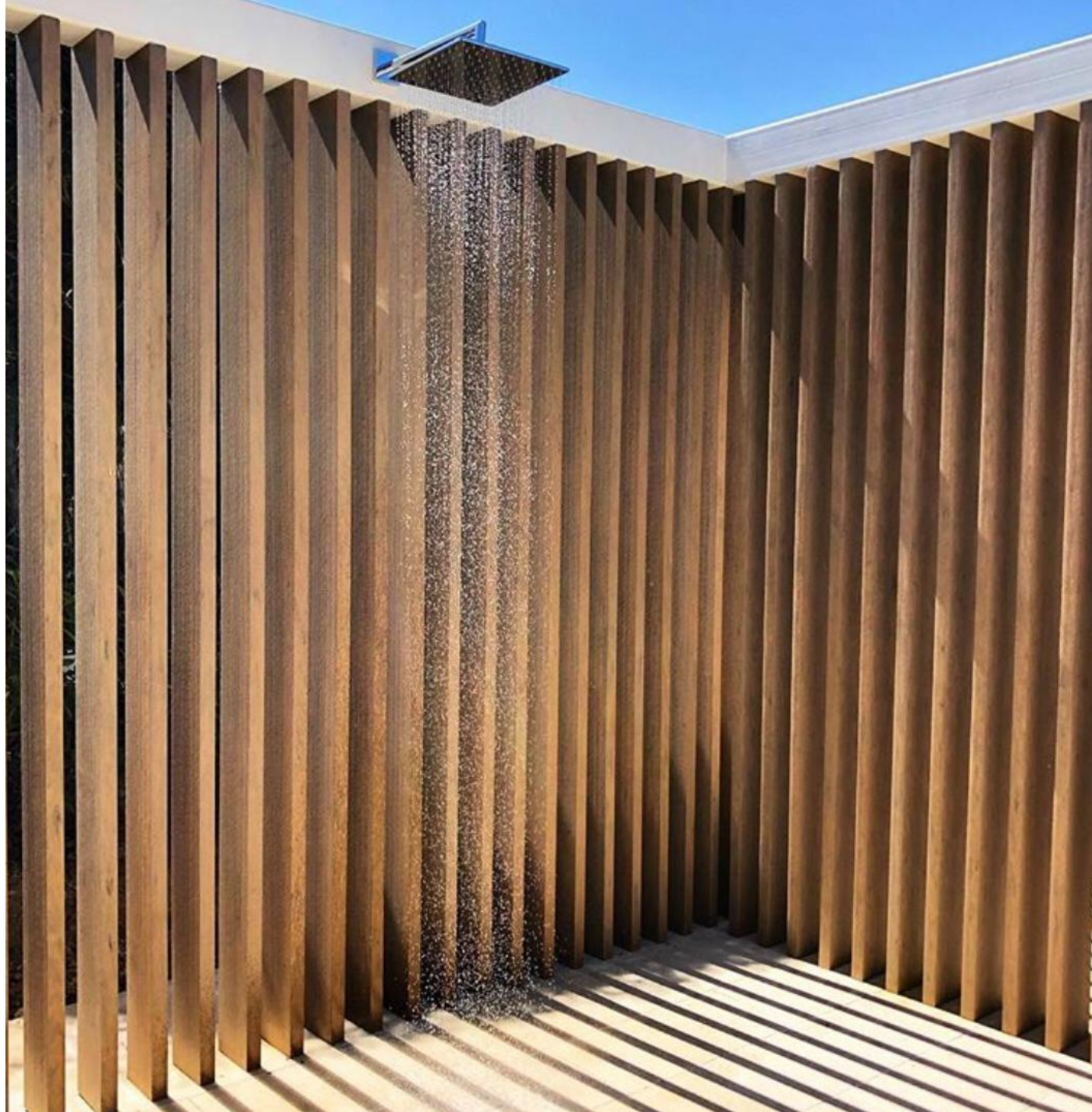

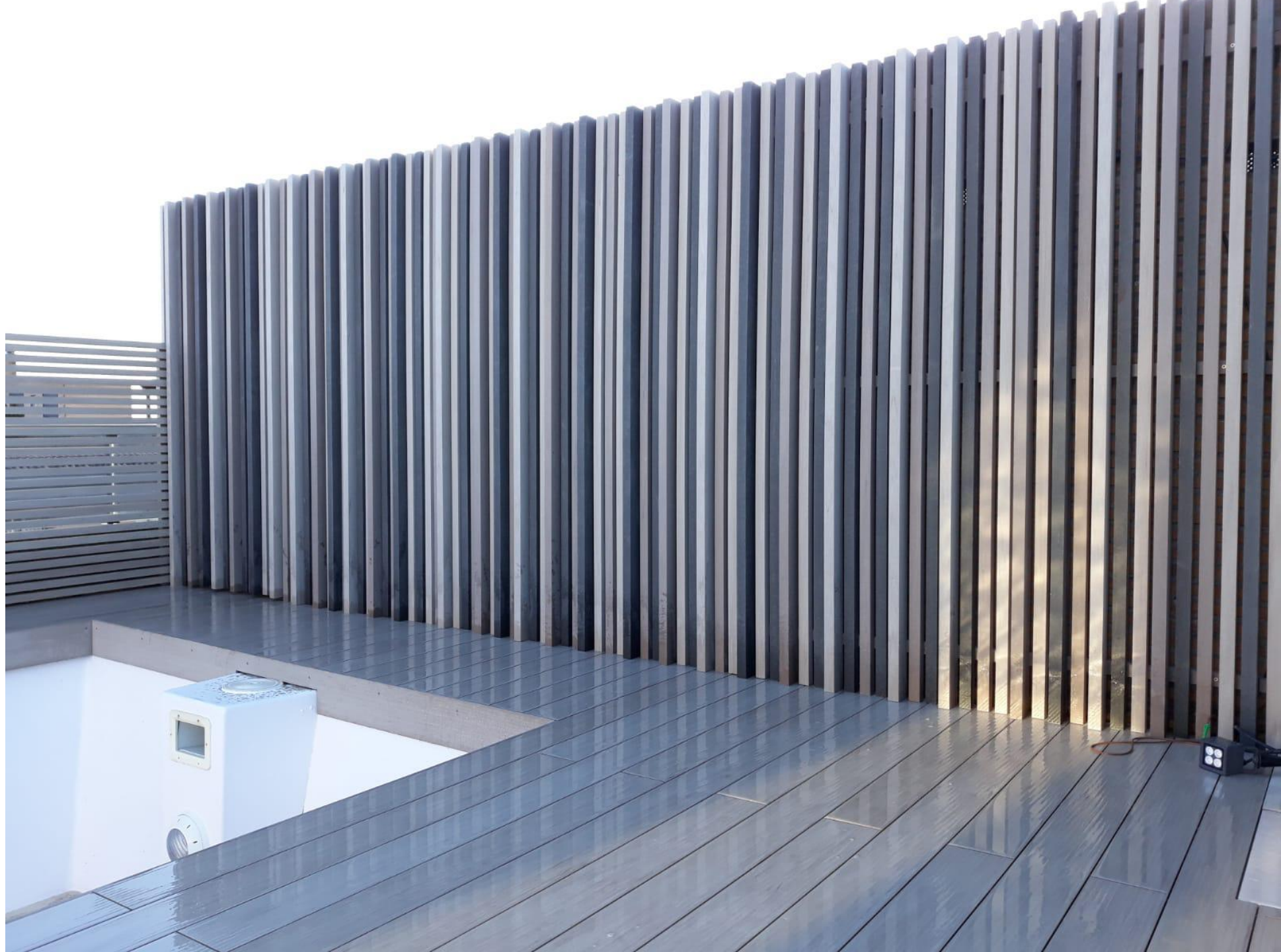























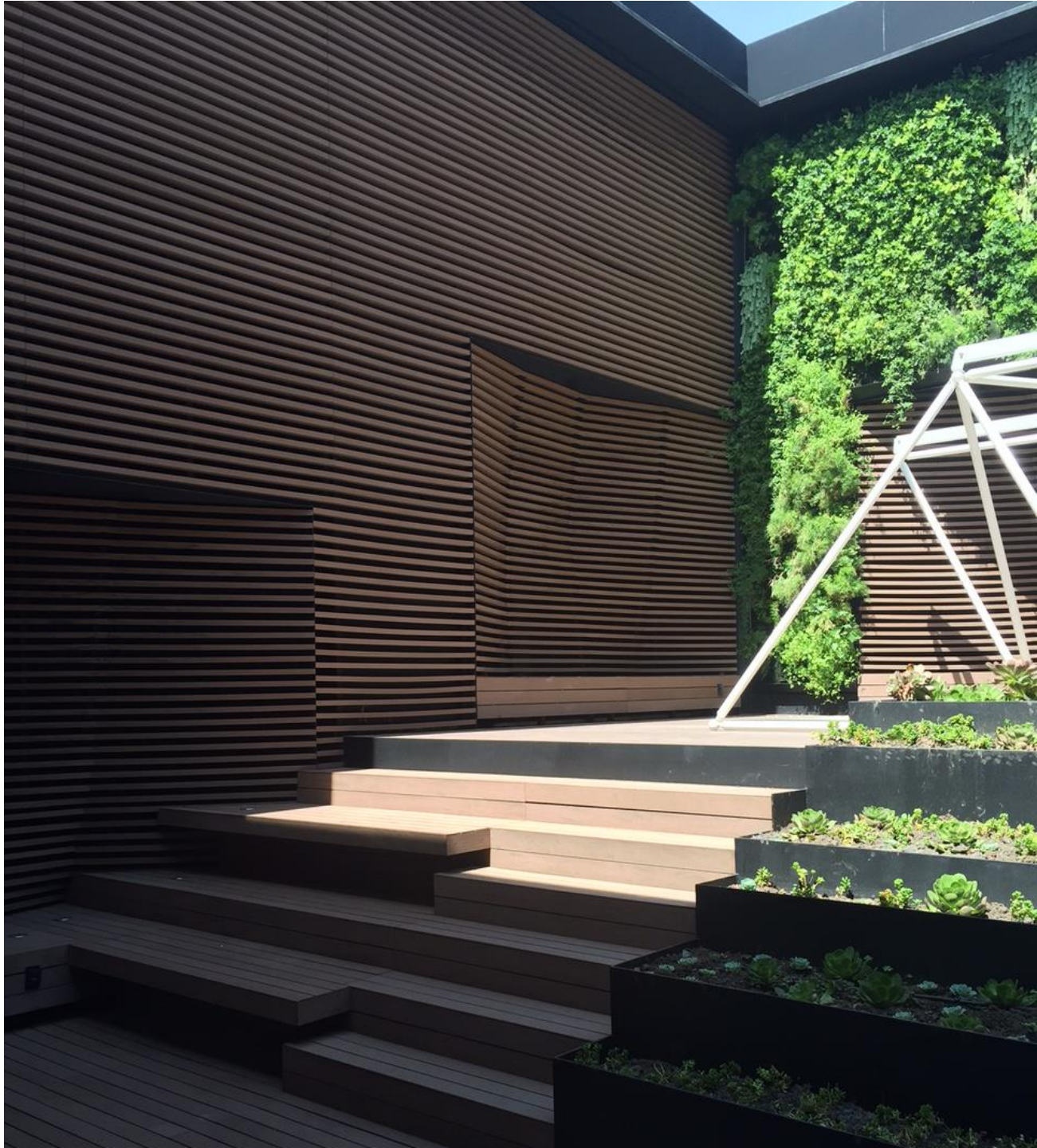

Hotel Serrano Palace
★ ★ ★ ★ ★



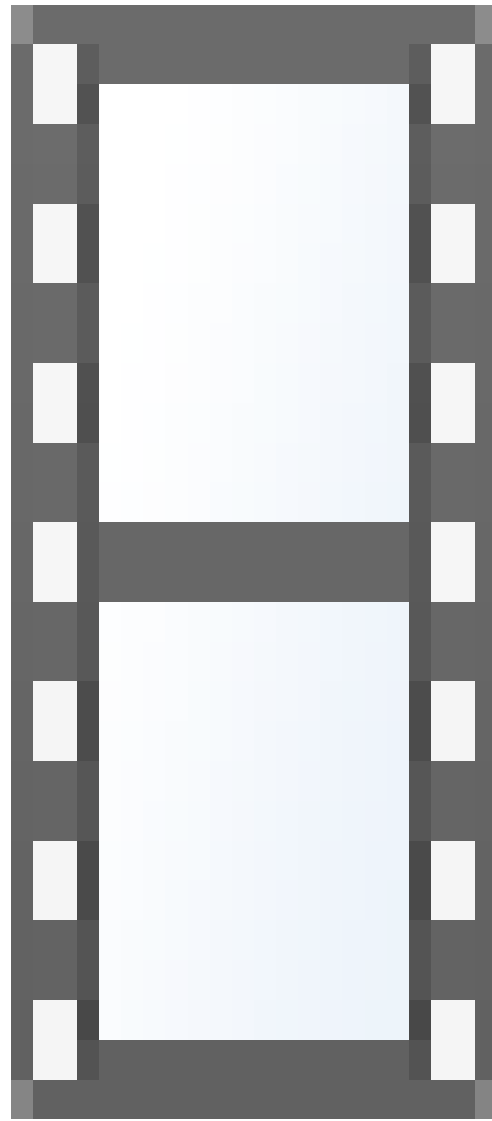















- 01. RASTREL Tarimatec® DE ALUMINIO "A" 30 x 50 mm
- 02. PERFIL DE INICIO Tarimatec® DE ALUMINIO 40 x 10 mm
- 03. CLIP Tarimatec® ACERO INOXIDABLE 40 x 45 mm
- 04. TORNILLO AUTOTALADRANTE Tarimatec® ACERO INOXIDABLE 4.2 x 25 mm
- 05. TARIMA Tarimatec® NATURE 150 x 27 mm
- 06. JUNTA DE GOMA 5 mm
- 07. TORNILLO A2 TACO DE GOLPEO DE ACERO INOXIDABLE 8 mm

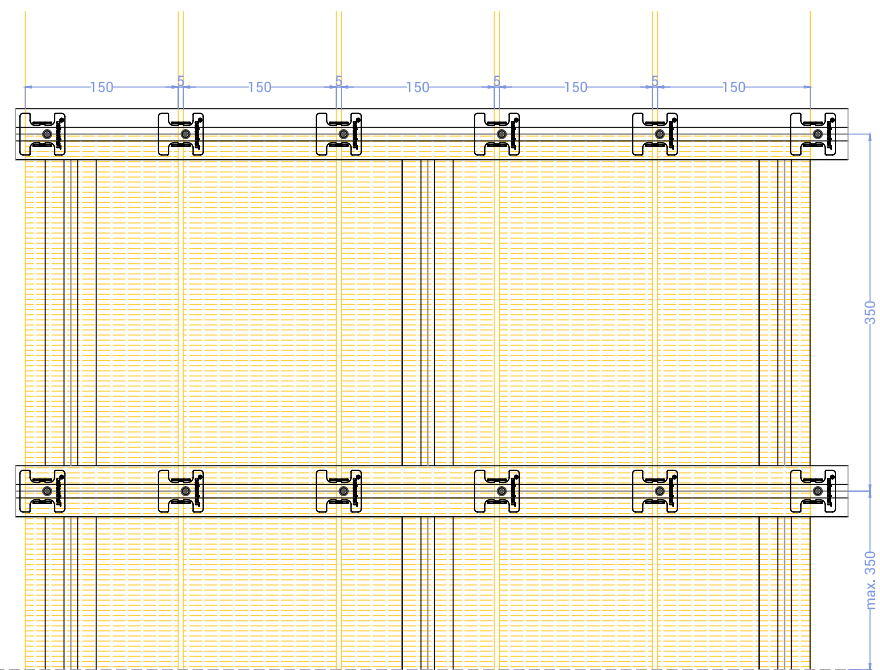
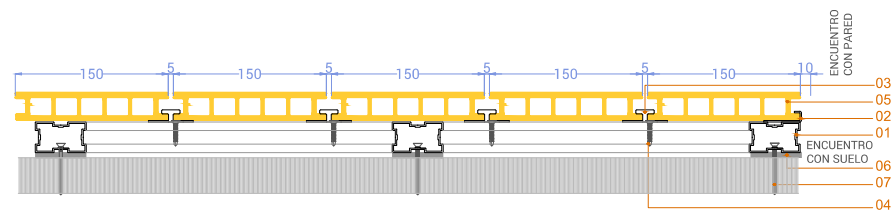

01. RASTREL Tarimatec® DE ALUMINIO "A" 30 x 50 mm
02. PERFIL DE INICIO Tarimatec® DE ALUMINIO 40 x 10 mm
03. CLIP Tarimatec® ACERO INOXIDABLE 40 x 45 mm
04. TORNILLO AUTOTALADRANTE Tarimatec® ACERO INOXIDABLE 4.2 x 25 mm
05. TARIMA Tarimatec® NATURE 150 x 27 mm
06. JUNTA DE GOMA 5 mm
07. TORNILLO A2 TACO DE GOLPEO DE ACERO INOXIDABLE 8 mm
08. TORNILLO AUTOTALADRANTE o ROSCA CHAPA SECCIÓN MÍNIMA 4 mm
09. TAPETA DE PERFIL MACIZO 179 X 10 mm

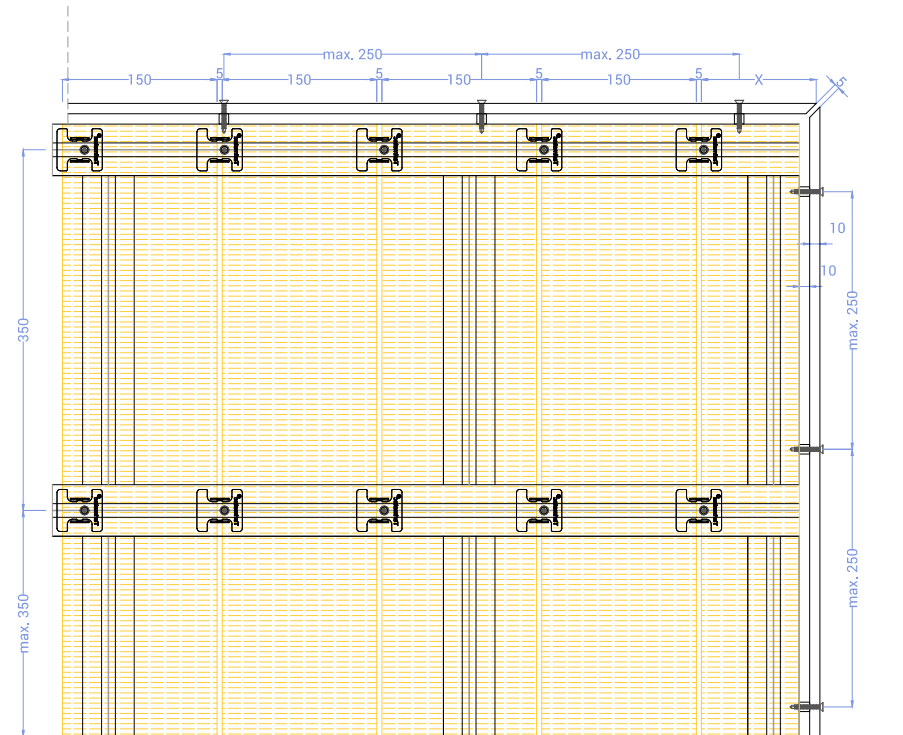
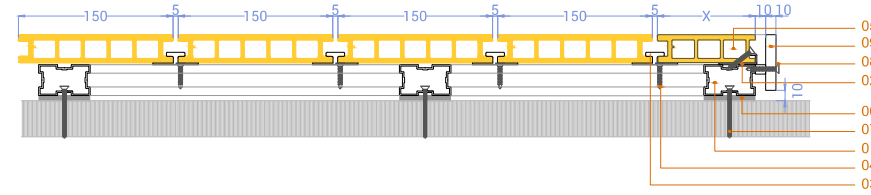

DISTANCIA TESTAS TAPETA MACIZA A INGLETE : 5 mm
 DISTANCIA DE TAPETA A TARIMA NATURE: 10 mm

- 01. RASTREL Tarimatec® DE ALUMINIO "A" 30 x 50 mm
- 02. PERFIL DE INICIO Tarimatec® DE ALUMINIO 40 x 10 mm
- 03. CLIP Tarimatec® ACERO INOXIDABLE 40 x 45 mm
- 04. TORNILLO AUTOTALADRANTE Tarimatec® ACERO INOXIDABLE 4.2 x 25 mm
- 05. TARIMA Tarimatec® NATURE 150 x 27 mm
- 06. PLOT REGULABLE Tarimatec® SP2

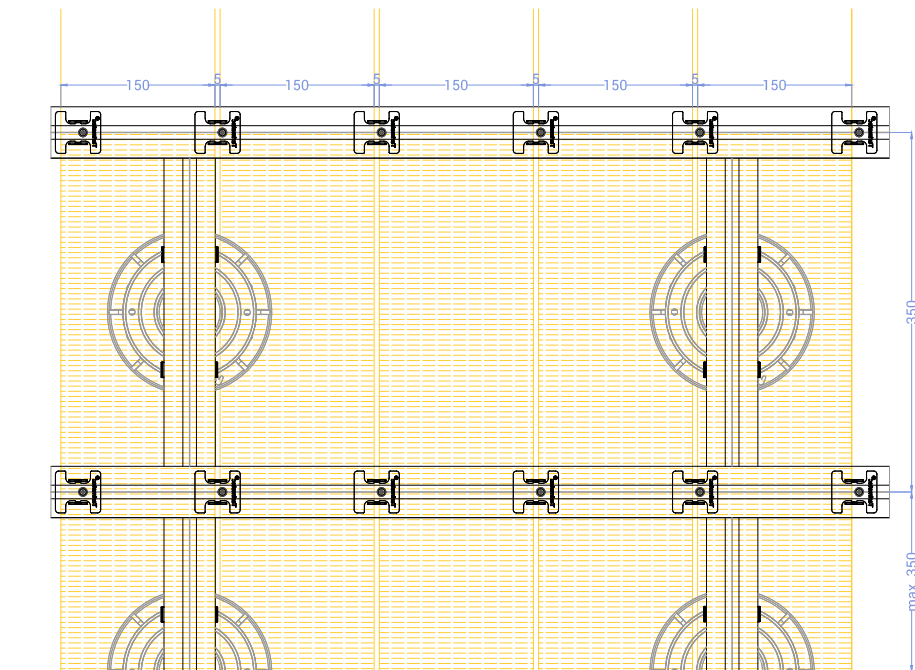
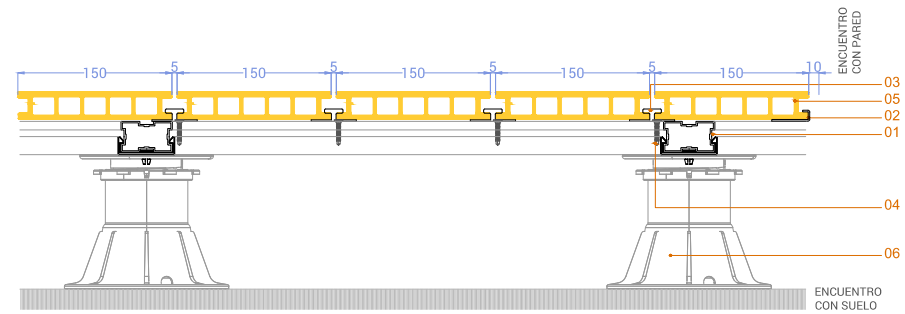

01. RASTREL Tarimatec® DE ALUMINIO "MONT BLANC" 30 x 45 mm
02. PERFIL DE INICIO Tarimatec® DE ALUMINIO 37 x 10 mm
03. CLIP Tarimatec® DE UNIÓN MONT BLANC 39 x 14,2 mm
04. TORNILLO AUTOTALADRANTE Tarimatec® ACERO INOXIDABLE 4.2 x 25 mm
05. PERFIL DE FACHADA Tarimatec® MONT BLANC 150 x 15 mm
06. TORNILLO A2 TACO DE GOLPEO DE ACERO INOXIDABLE 8 mm
07. TAPETA DE PERFIL MACIZO 179 X 10 mm
08. TORNILLO AUTOTALADRANTE o ROSCA CHAPA SECCIÓN MÍNIMA 4 mm

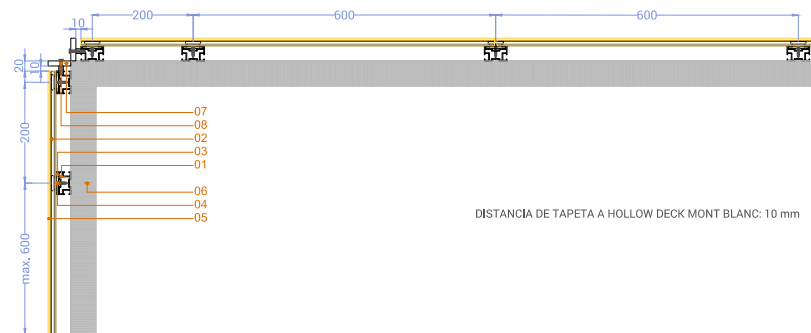
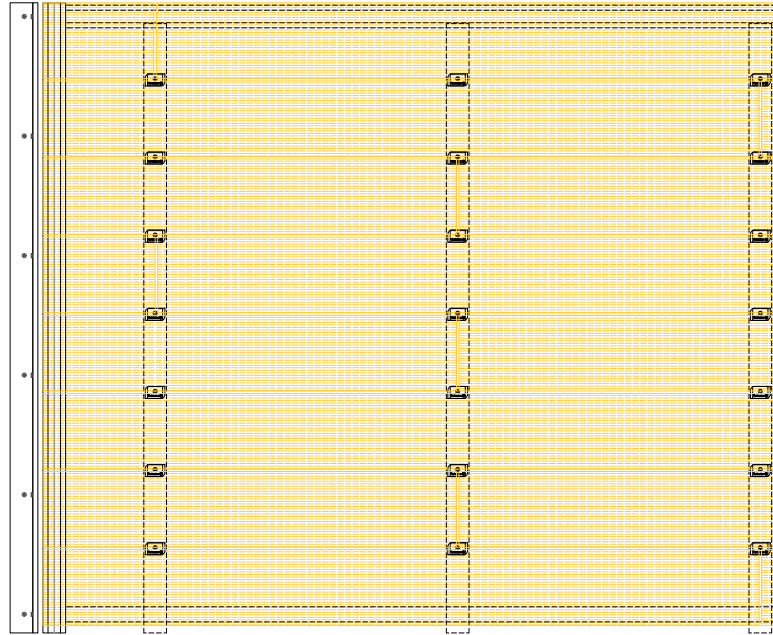

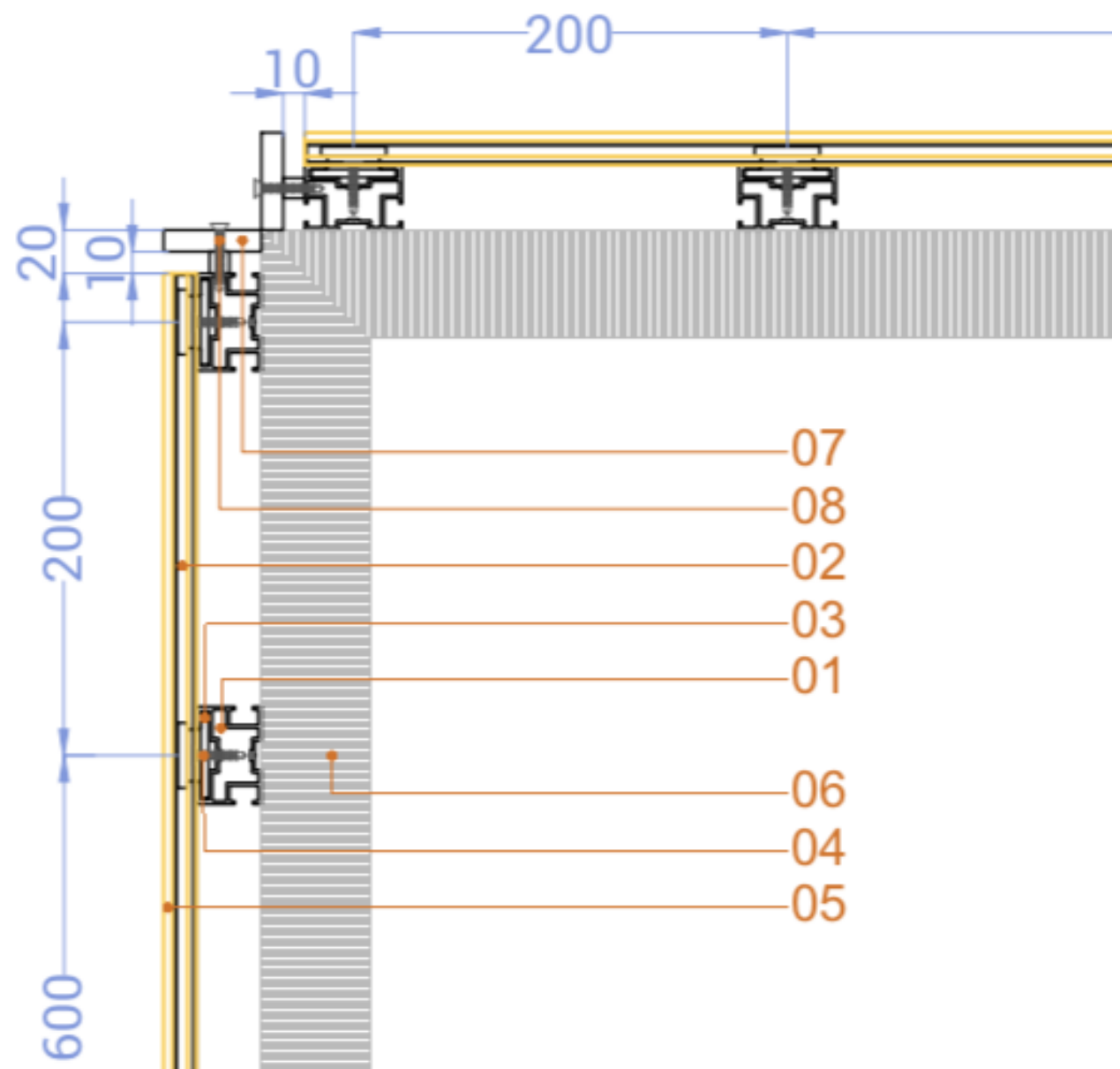

01. RASTREL Tarimatec® DE ALUMINIO "MONT BLANC" 30 x 45 mm
02. PERFIL DE INICIO Tarimatec® DE ALUMINIO 37 x 10 mm
03. CLIP Tarimatec® DE UNIÓN MONT BLANC 39 x 14,2 mm
04. TORNILLO AUTOTALADRANTE Tarimatec® ACERO INOXIDABLE 4.2 x 25 mm
05. PERFIL DE FACHADA Tarimatec® MONT BLANC 150 x 15 mm
06. TORNILLO A2 TACO DE GOLPEO DE ACERO INOXIDABLE 8 mm
07. CORTE A INGLETE DE PERFIL DE FACHADA Tarimatec® MONT BLANC 5 mm

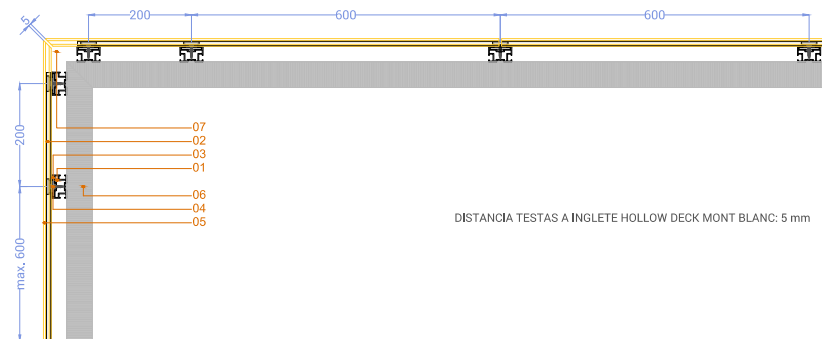
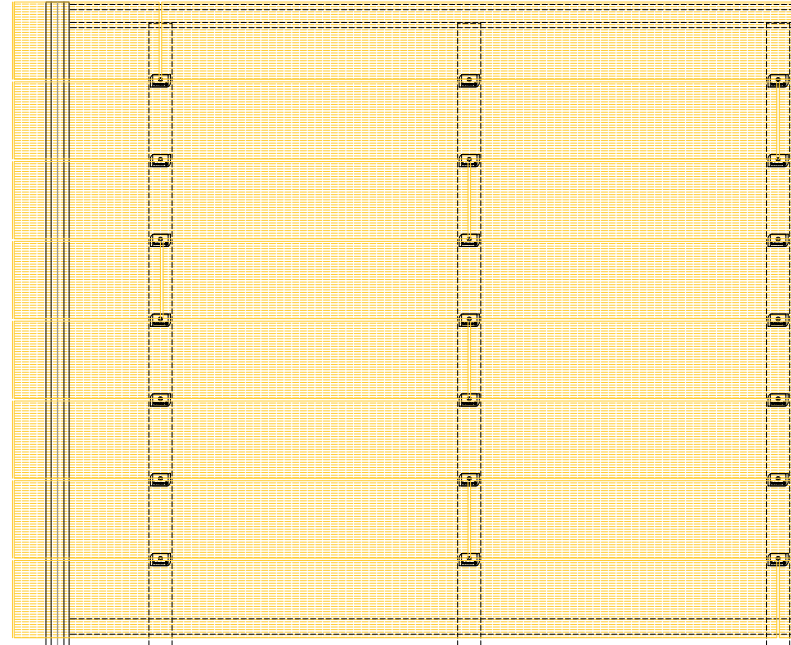

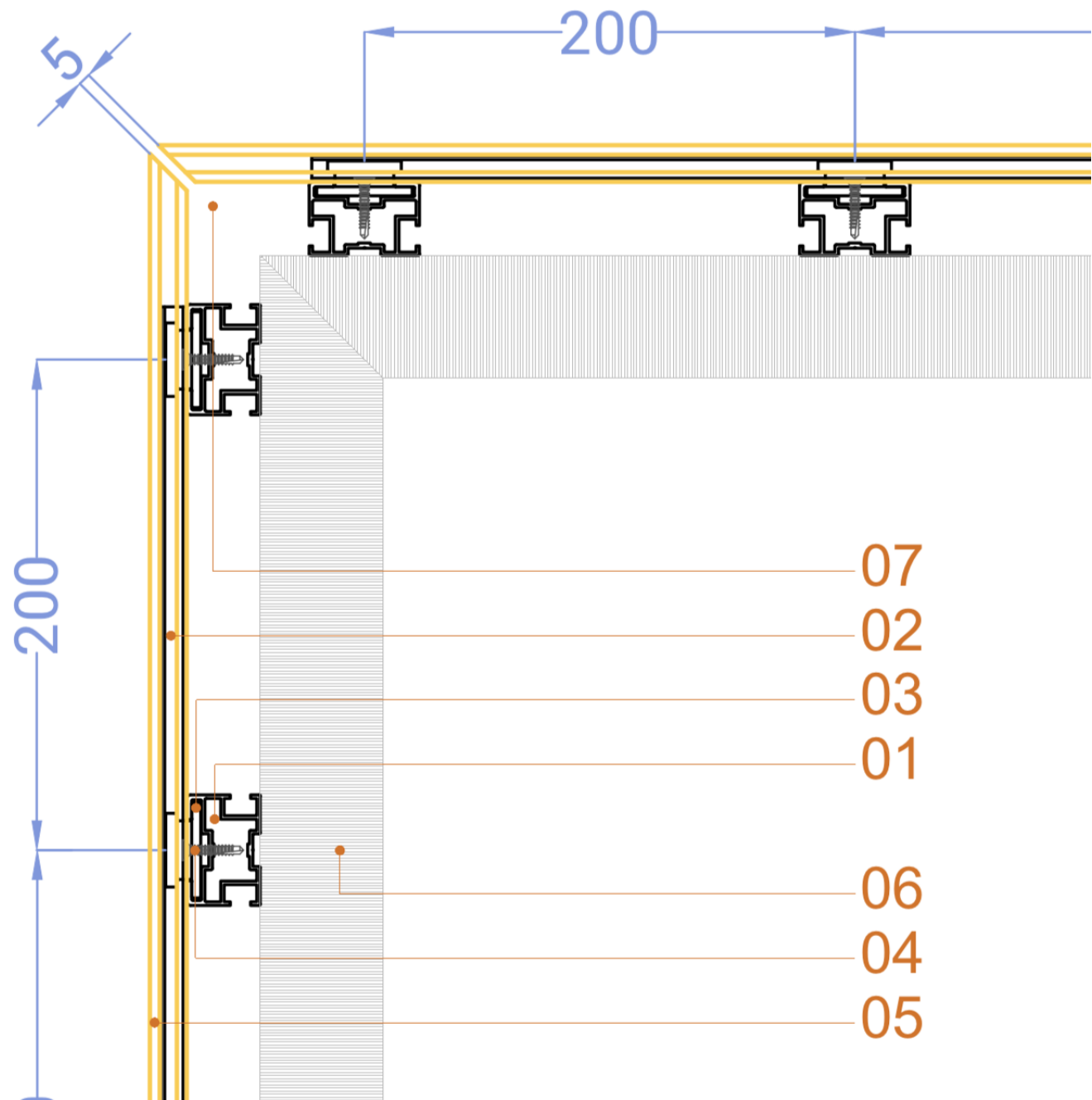

01. RASTREL Tarimatec® "ANNAPURNA" 40 x 40 x 3000 mm
02. PERFIL ANGULAR Tarimatec® DE ALUMINIO LACADO NEGRO 40 x 40 x 2 mm
03. REMACHE ESTÁNDAR PLANO Tarimatec® ACERO INOXIDABLE 3 mm
04. BASTIDOR DE PERFIL CUADRADO Tarimatec® ALUMINIO LACADO NEGRO 40 x 40 x 2 mm
05. ESCUADRA DE ALUMINIO L8-3736-C DE 40 X 40 mm Y HORQUILLA ANODIZADA EN NEGRO
06. TACO NORMAL O MECÁNICO DE ACERO INOXIDABLE, SEGÚN SOPORTE

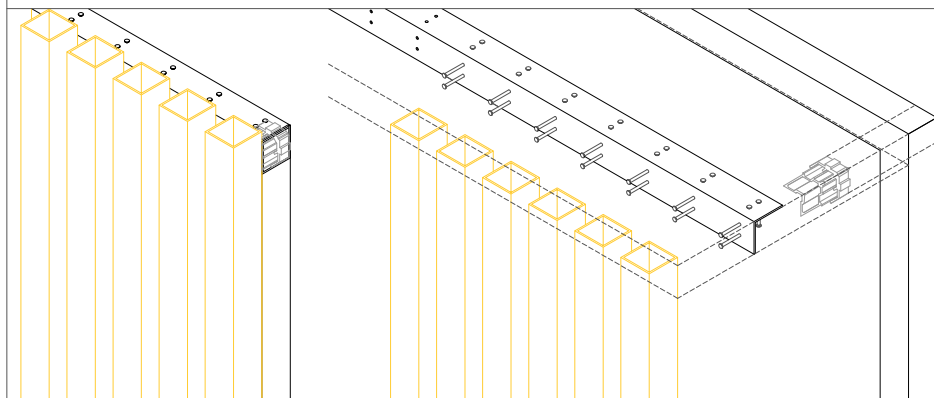
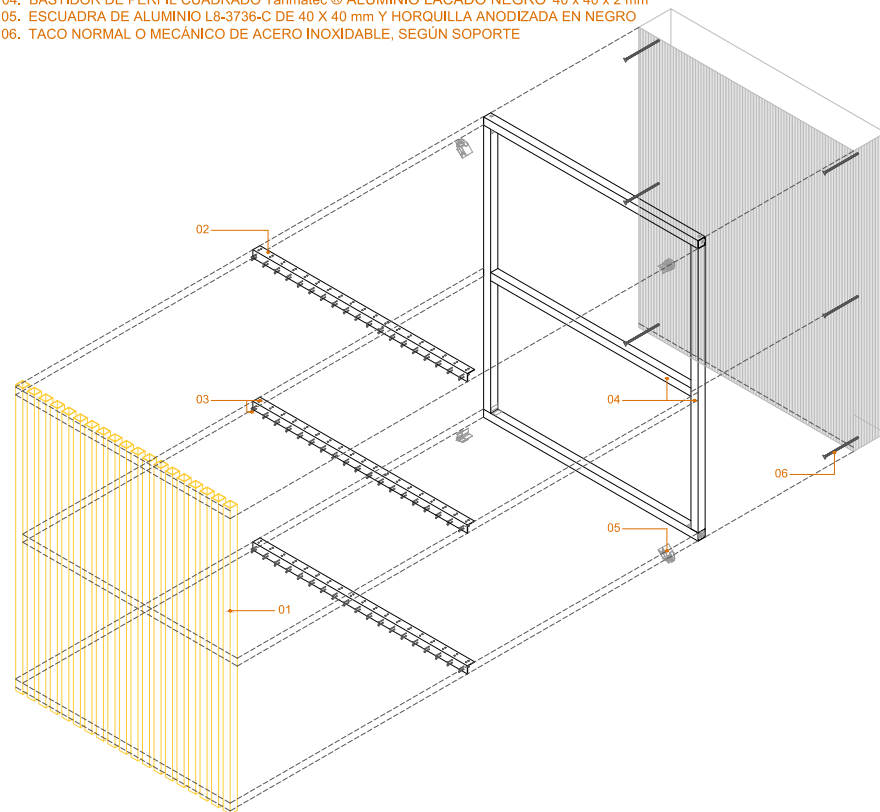

01. RASTREL Tarimatec © "ANNAPURNA" 40 x 40 x 3000 mm
02. PERFIL ANGULAR Tarimatec © DE ALUMINIO LACADO NEGRO 40 x 40 x 2 mm
03. TRAVESAÑO Tarimatec © DE ALUMINIO LACADO NEGRO 40 x 40 x 2 mm
04. REMACHE ESTANDAR PLANO Tarimatec © ACERO INOXIDABLE 3 mm
05. TACO NORMAL O MECÁNICO DE ACERO INOXIDABLE, SEGÚN SOPORTE
06. BASTIDOR DE PERFIL CUADRADO Tarimatec © DE ALUMINIO LACADO NEGRO 40 x 40 x 2 mm
07. ESCUADRA DE ALUMINIO L8-3736-C DE 40 X 40 mm Y HORQUILLA ANODIZADA EN NEGRO

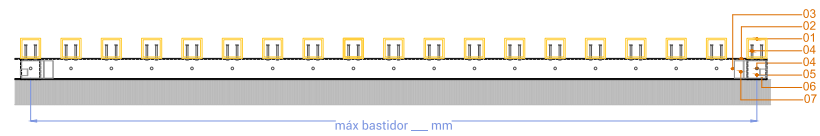
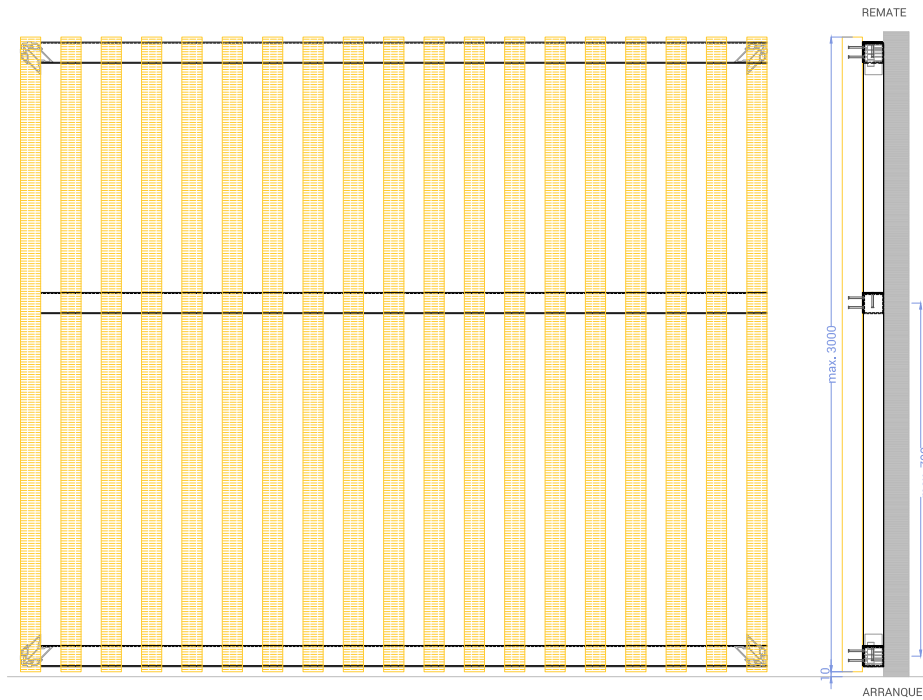

01. RASTREL Tarimatec® "ANNAPURNA" 40 x 40 x 3000 mm
02. PERFIL ANGULAR Tarimatec® DE ALUMINIO LACADO NEGRO 40 x 40 x 2 mm
03. TRAVESAÑO Tarimatec® DE ALUMINIO LACADO NEGRO 40 x 40 x 2 mm
04. REMACHE ESTANDAR PLANO Tarimatec® ACERO INOXIDABLE 3 mm
05. TACO NORMAL O MECÁNICO DE ACERO INOXIDABLE, SEGÚN SOPORTE
06. BASTIDOR DE PERFIL CUADRADO Tarimatec® DE ALUMINIO LACADO NEGRO 40 x 40 x 2 mm
07. ESCUADRA DE ALUMINIO L8-3736-C DE 40 X 40 mm Y HORQUILLA ANODIZADA EN NEGRO
08. VARILLA ROSCADA DE CUELGUE DE ACERO INOXIDABLE
09. TUERCA Y ARANDELA DE ACERO INOXIDABLE
10. TAPA DE CIERRE EN BORDE EXTREMO DE RASTREL Tarimatec® "ANNAPURNA"

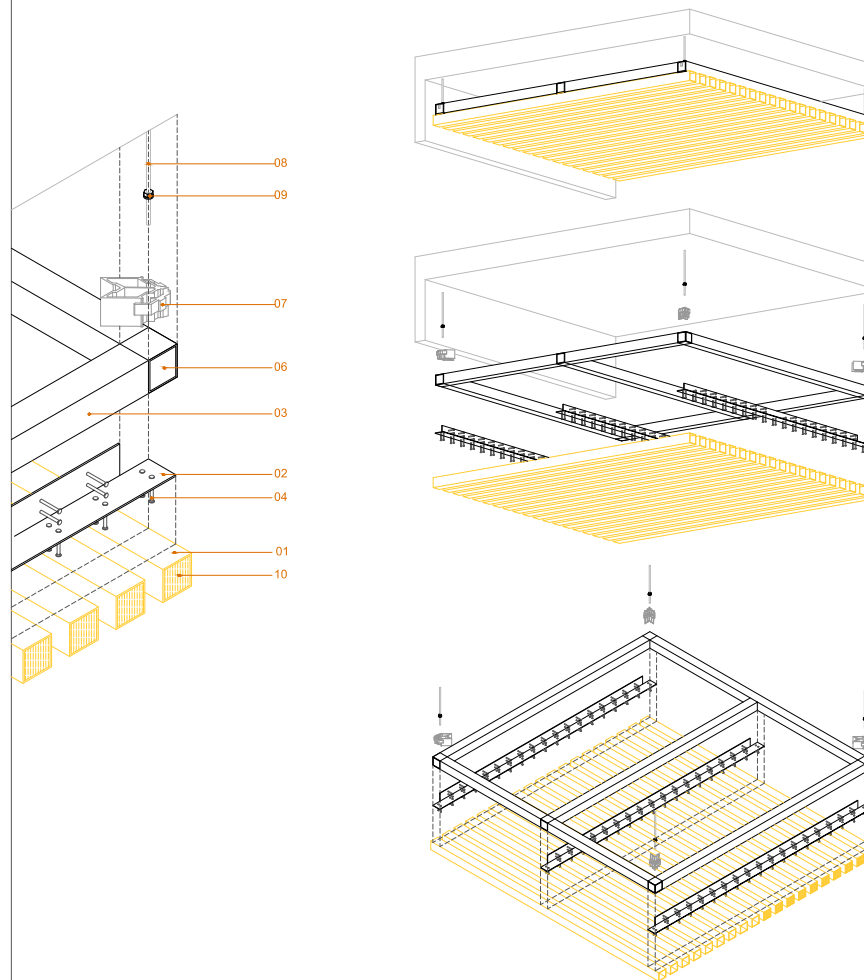



Tarimatec

P01 MARQUESINA Tarimatec® ANNAPURNA

E: 1 / 20

- 01. BASTIDOR DE PERFIL CUADRADO Tarimatec® ALUMINIO LACADO NEGRO 40 x 40 x 2 mm
- 02. BASTIDOR DE PERFIL CUADRADO Tarimatec® ALUMINIO LACADO NEGRO 40 x 40 x 2 mm
- 03. BASTIDOR DE PERFIL CUADRADO Tarimatec® ALUMINIO LACADO NEGRO 40 x 40 x 2 mm
- 04. BASTIDOR DE PERFIL CUADRADO Tarimatec® ALUMINIO LACADO NEGRO 40 x 40 x 2 mm
- 05. TACOS NORMAL O MECANICO DE ACERO INOXIDABLE, SEGUN SOPORTE

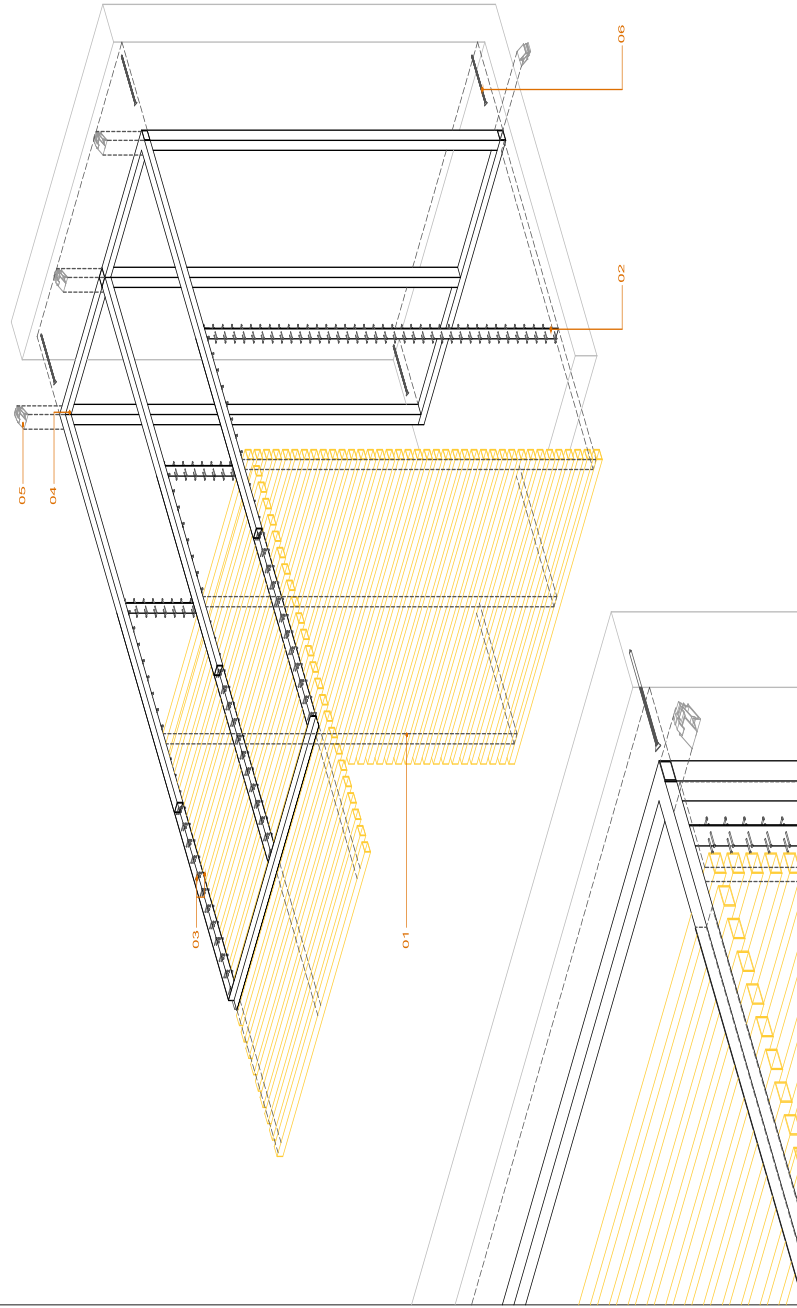



Tarimatec

P03 PARABAN Tarimatec® ANNAPURNA

E: 1 / 20

01. RASTREL Tarimatec® "ANNAPURNA", 40 x 40 x 3000 mm
02. RASTREL Tarimatec® "ANNAPURNA", 40 x 40 x 3000 mm
03. REMACHE ESTÁNDAR PLANO Tarimatec® ACERO INOXIDABLE 3 mm
04. BASTIDOR DE PERFIL CUADRADO Tarimatec® ALUMINIO LACADO NEGRO 40 x 40 x 2 mm
05. ESCUADRA DE ALUMINIO L8-3736-C DE 40 X 40 mm Y HORQUILLA ANODIZADA EN NEGRO
06. RIGIDIZADOR 30 X 30 X 2 mm DE ACERO GALVANIZADO
07. TAPA DE CIERRE EN BORDE Tarimatec® ALUMINIO Y FRENO DELANTERO
08. TAPA DE CIERRE EN BORDE EXTREMO DE RASTREL Tarimatec® "ANNAPURNA"

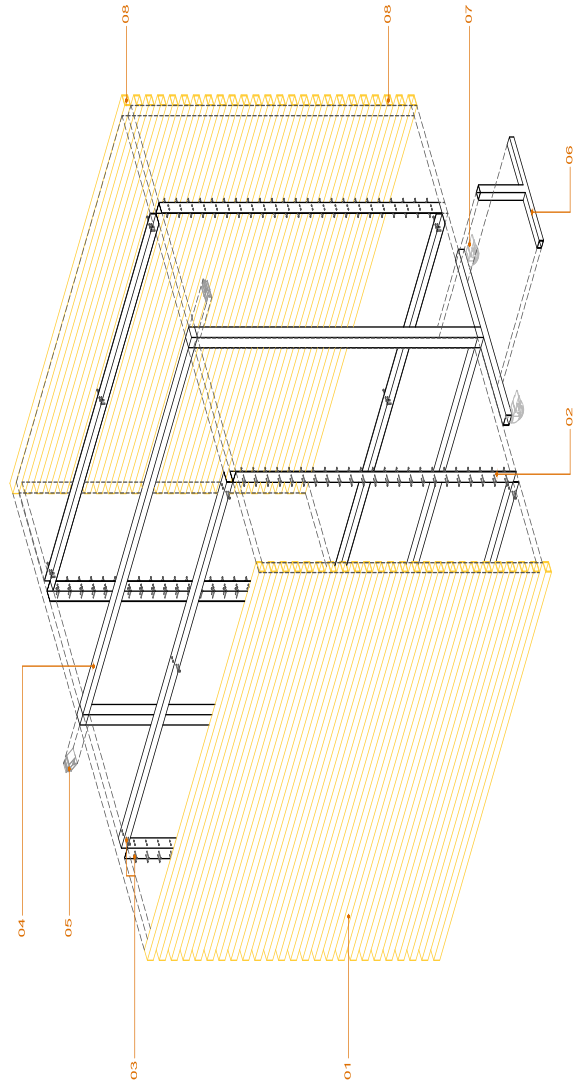



- 01. RASTREL Tarimatec® "ANNAPURNA" 40 x 40 x 3000 mm
- 02. PERFIL Tarimatec® DE ALUMINIO LACADO NEGRO 40 x 40 x 2 mm
- 03. TRAVESAÑO TANDAR Tarimatec® DE ALUMINIO LACADO NEGRO 40 x 40 x 2 mm
- 04. TRAVESAÑO TANDAR Tarimatec® DE ALUMINIO LACADO NEGRO 40 x 40 x 2 mm
- 05. REMACHE ESTANDAR PLANO Tarimatec® ACERO INOXIDABLE 3 mm
- 06. BASTIDOR DE PERFIL CUADRADO Tarimatec® DE ALUMINIO LACADO NEGRO 40 x 40 x 2 mm
- 07. ESCUADRA DE ALUMINIO L8-3736-C DE 40 X 40 mm Y HORQUILLA ANODIZADA EN NEGRO 40 x 40 x 2 mm
- 08. RUEDA INDUSTRIAL 60 mm SOPORTE ESPIGA GIRATORIO Y FRENO DELANTERO
- 09. RUEDA INDUSTRIAL 60 mm SOPORTE ESPIGA GIRATORIO Y FRENO DELANTERO
- 10. TAPA DE CIERRE EN BORDE EXTREMO DE RASTREL Tarimatec® "ANNAPURNA"

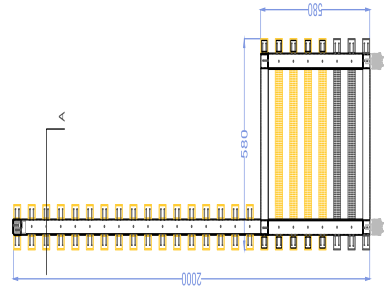

SOPORTE HORIZONTAL

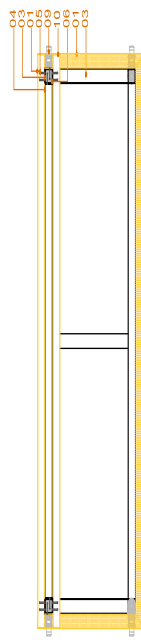
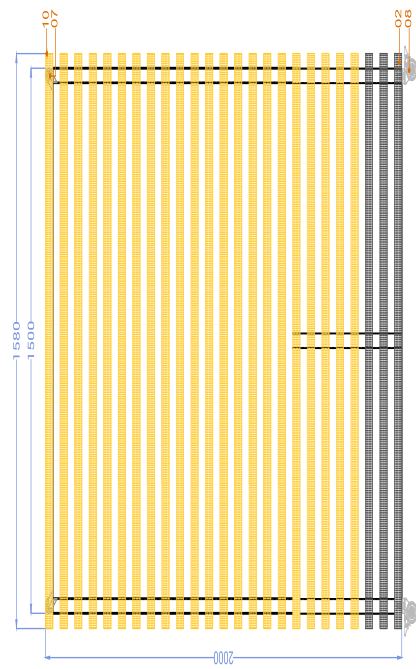

A

MUCHAS GRACIAS

