

viroc
by Investwood

FOTO DE CAPA | COVER PHOTO

Black Viroc walls cladding and Facades | Vivood Hotel, Daniel Mayo, Agustín Marí, Pablo Vázquez | Alicante, Spain



Grey Viroc facades | Rocco Vidal P+W | Brazil

CONCEITO | CONCEPT

Viroc® Cement Bonded Particle Board

PT

O Viroc é um painel compósito constituído por uma mistura de partículas de madeira e cimento. Combina a flexibilidade da madeira com a resistência e durabilidade do cimento, permitindo uma vasta gama de aplicações, tanto no interior como no exterior. A sua aparência não é homogénea, sendo uma característica natural do produto.

Pode ser calibrado/lixado (para aplicações que exigem menores tolerâncias). Uma vez calibrado, apresenta partículas de madeira visíveis na superfície do painel.

EN

Viroc is a composite material, composed by a compressed and dry mixture of pine wood particles and cement. It combines the flexibility of wood with the strength and durability of cement, allowing a large range of applications, both indoor and outdoor. Viroc presents a non-homogeneous appearance, a product natural feature.

Viroc can be factory calibrated/sanded (for applications requiring tighter tolerances). Once calibrated, presents visible wood particles on the surface.

GAMA | RANGE

Cores | Colours

Lixado | Sanded

Bruto | Raw

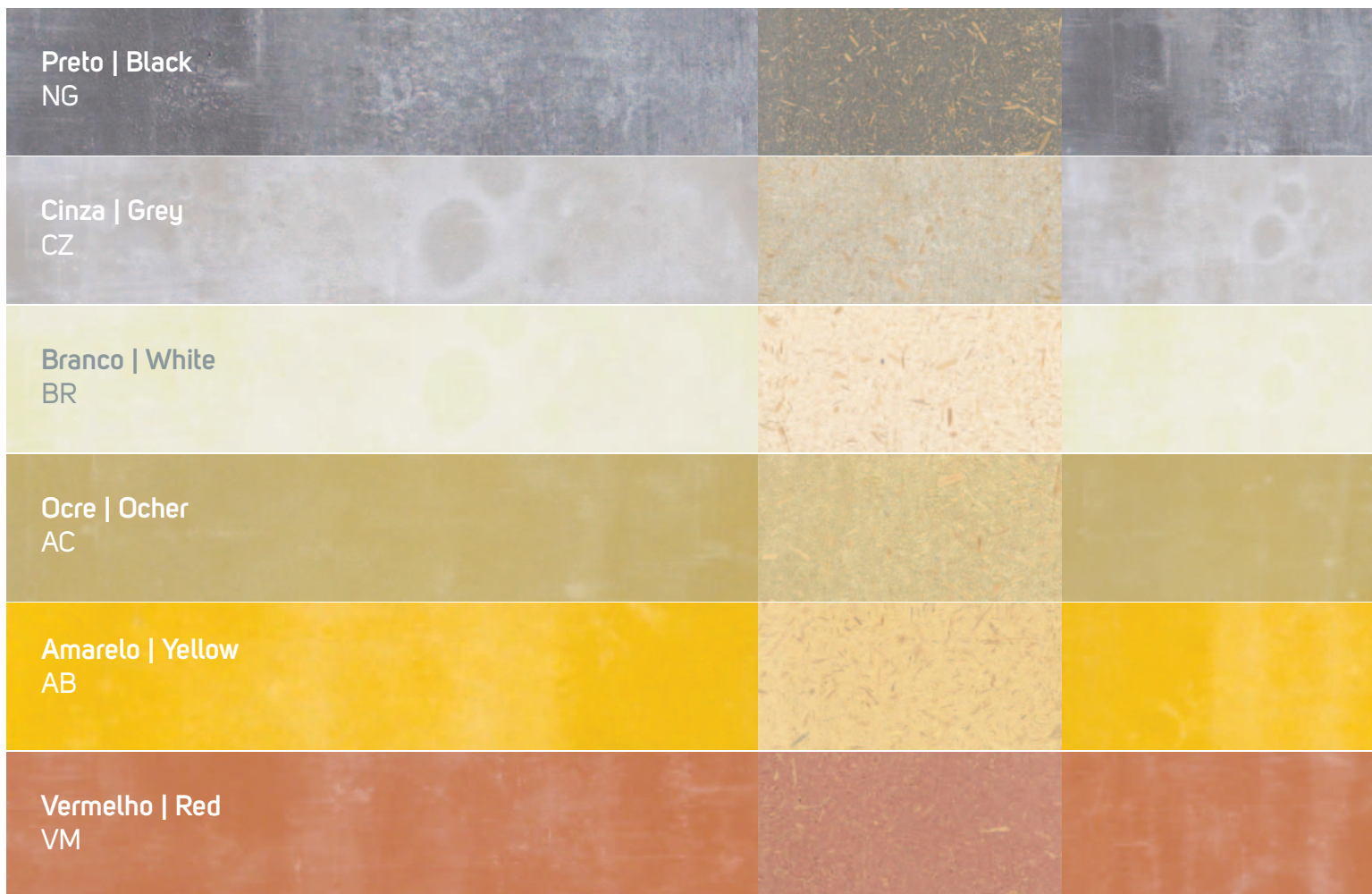

PT

O painel Viroc pode ser fornecido bruto, polido ou lixado.

Bruto: painel natural com as superfícies em cimento

Polido: painel natural com as superfícies polidas

Lixado: painel calibrado com partículas de madeiras visíveis na superfície

EN

The Viroc panel can be supplied raw, polished or sanded.

Raw: natural panel with cement surfaces

Polished: natural panel with polished surfaces

Sanded: panel calibrated with visible wood particles on the surface

Espessuras | Thicknesses (mm)

Dimensões | Dimensions (mm)

8 10 12 15 16 18 19 21 22 24 28 32



3000x1250
2600x1250



2600x1250





Grey Viroc facades and walls cladding | Maison MTU | Dank Architects | Lyon, France



VANTAGENS | ADVANTAGES



Não Tóxico
Non Toxic



Ignífugo
Fire Retardant



Isolante Acústico
Sound Insulation



Hidrófugo
Moisture Resistant



Resistente a Cargas
Weight Resistant



Isolante Térmico
Thermal Insulation



Fácil Instalação
Easy Installation



Resistente a Insectos
Insect Resistant

APLICAÇÕES | APPLICATIONS

PT

Exteriores e Interiores

Fachadas, paredes, pavimentos, suporte de coberturas, tectos, mobiliário, decoração de interiores, mobiliário urbano, cofragem perdida e outros.

EN

Outdoor and Indoor

Facades, partition walls, flooring, roof structures, ceilings, furniture, interior decoration, urban furniture, walls cladding and others.

FACHADAS | FACADES



White Viroc walls cladding, flooring and suspended ceiling | Stand Odebrecht | Márcio Corrêa, Atelier Dupla Arquitetura Estratégica | Brasília, Brazil





Ocher Viroc Facades | Adega | Metalovimac | Torres Vedras, Portugal



Grey Viroc Facades | Instituto D. Ana Rosa | Rocco Vidal P+W | São Paulo, Brazil







Grey Viroc facades | Casa Decor 2011 | Carlos Marsi | São Paulo, Brazil



Ventilated Facades – Viroclin | MB-Arquitectos | Beira Baixa, Portugal

FACHADAS | FACADES

SISTEMA DE PARAFUSOS | VENTILATED FACADES SCREW SYSTEM



PT

Aplicação exteriores**Estrutura de suporte** madeira ou metal**Fixação** parafusos de cabeça exterior ou rebite**Espessura** 12 mm ou 16 mm**Medida máxima do painel****Estrutura de madeira** 3000 x 1250 mm**Estrutura metálica** 1500 x 1250 m

EN

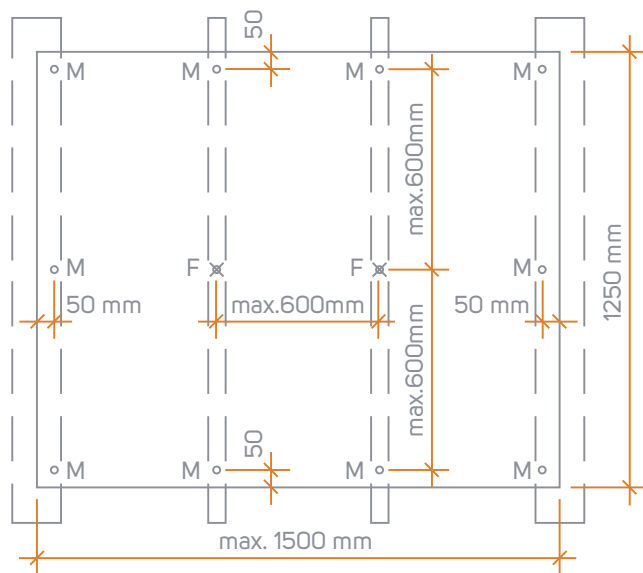
Application outdoors**Support structure** wood or metal**Fastening** external head screws or rivets**Thickness** 12 mm (1/2") or 16 mm (5/8")**Board maximum size****Wood structure** 3000 x 1250 mm (118,11" x 49,21")**Metallic structure** 1500 x 1250 mm (59,00" x 49,21")

PT

Estrutura de suporte metálica

EN

Metal support structure

Localização das fixações do painel
Location of the panel fastenings

PT

Estrutura de suporte
de madeira

EN

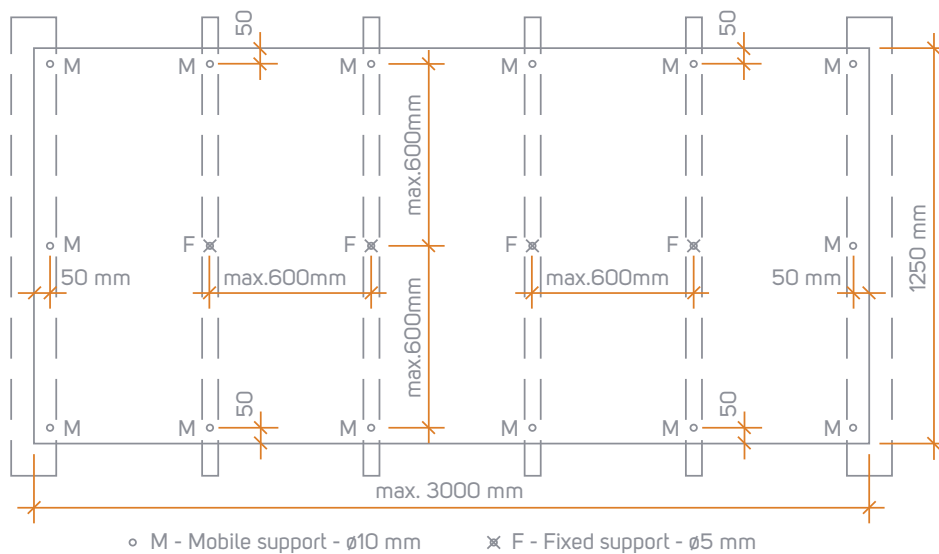
Wood support
structure

Localização das fixações do painel
Location of the panel fastenings

PT

Parafusos ou rebites para fixação em estrutura de
metal.

EN

Screws and rivets for fastening in metal structure.



PT

Parafusos para fixação em estrutura de madeira.

EN

Screws for fastening in wood structure

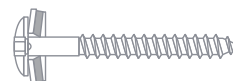

FACHADAS | FACADES

SISTEMA VIROCLIN | VIROCLIN VENTILATED FACADES

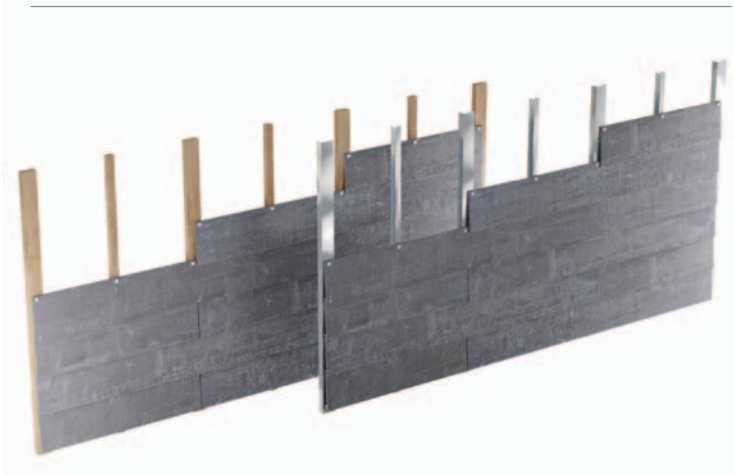

PT

Aplicação exteriores**Estrutura de suporte** madeira ou metal**Fixação** oculta com parafusos**Espessura** 15 mm**Medida máxima do painel** 2440 x 300 mm

EN

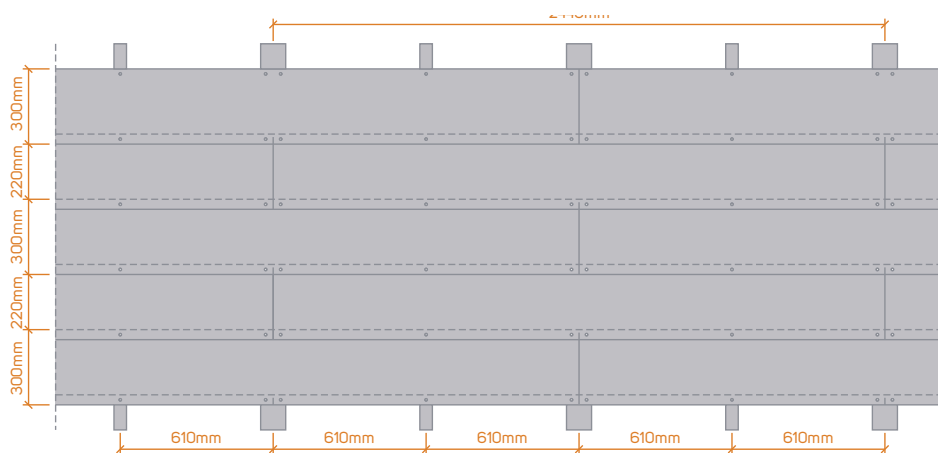
Application outdoors**Support structure** wood or metal**Fastening** hidden with screws**Thickness** 15 mm (9/16")**Board maximum size** 2440 x 300 mm (96" x 11,81")

PT

No sistema Viroclin os painéis são fixos à estrutura de suporte por encaixes sucessivos através de dispositivos de plástico rígido e parafusos.

EN

In the Viroclin system the panels are fixed to the support structure by successive fittings through rigid plastic devices and screws.

Localização das fixações do painel
Location of the panel fastenings

PT

Parafuso para
estrutura metálica

EN

Screws for metal
structure

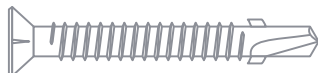

PT

Parafuso para estrutura
de madeira

EN

Screws for wood
structure

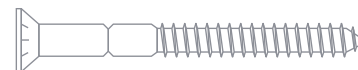

FACHADAS | FACADES

SISTEMA DE FIXAÇÃO MISTO | VENTILATED FACADES MIXED SYSTEM

PT

Aplicação exteriores

Estrutura de suporte madeira ou metal

Fixação parafusos e sistema de colagem

Espessura 12 mm ou 16 mm

Tamanho máximo do painel 3000 x 1250 mm

EN

Application outdoors

Support structure wood or metal

Fastening screws and bonding system

Thickness 12 mm (1/2") or 16 mm (5/8")

Board maximum size 3000 x 1250 mm
(118,11" x 49,21")

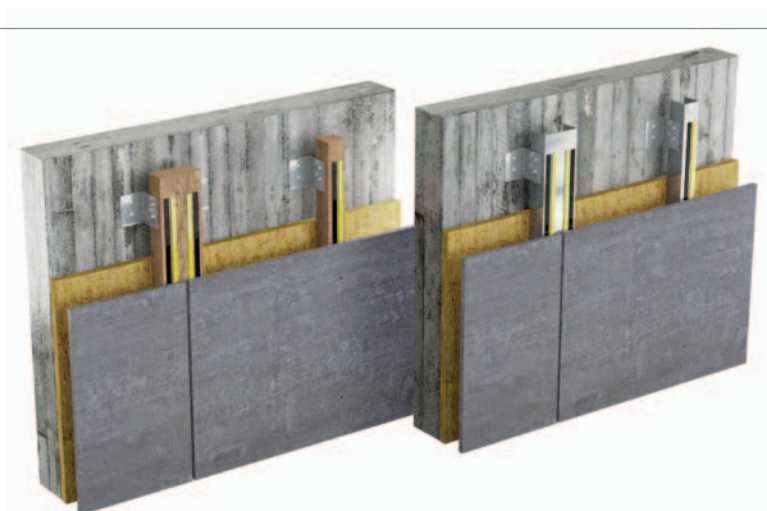

PT

O painel negro, pelas suas características, será limitado à máxima dimensão de 1500x1250mm. No sistema misto, os painéis Viroc são fixos à estrutura de suporte por um sistema de colagem e parafusos colocados na zona central.

EN

The Black panel, due to its characteristics, will be limited to the maximum dimension of 1500x1250mm.

In the mixed system the Viroc panels are fixed to the support structure by a bonding system and the screws are placed in the central zone.

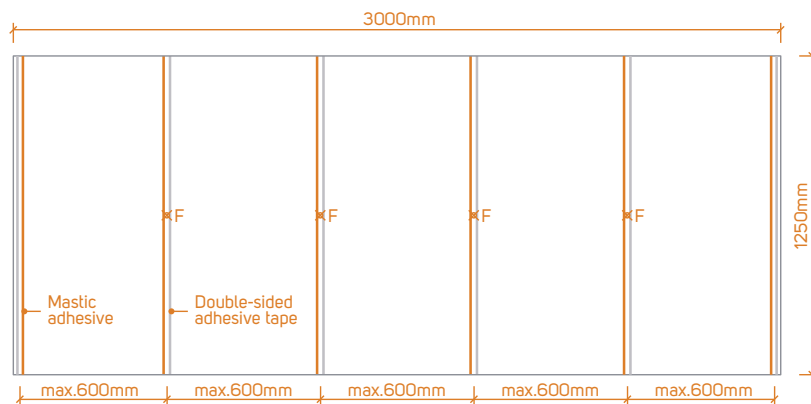

× F - Fixed support

Localização das fixações do painel
Location of the panel fastenings

PT

Parafuso para estrutura metálica

EN

Screws for metal structure



PT

Parafuso para estrutura de madeira

EN

Screws for wood structure

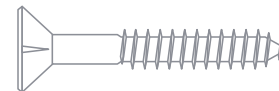

PAVIMENTOS | FLOORING

Grey Viroc walls and floor | Calmani | Architect Nightingale | Alexandre Vanbattel | Belgium



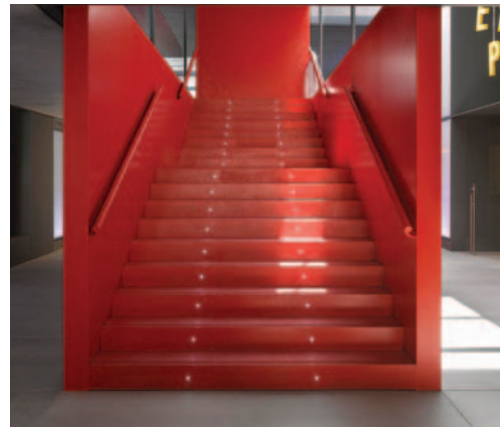

Grey Viroc floor | Casa del Lector | Antón García | Madrid, Spain

PAVIMENTOS | FLOORING

VIROC BRUTO | UNSANDED FLOOR

PT

Aplicação interiores

Estrutura de suporte madeira ou metal

Fixação sistema de colagem ou parafusos

Espessura ≥ 19 mm

Tamanho máximo do painel 3000x1250 mm

EN

Application indoors

Support structure wood or metal

Fastening bonding system or screws

Thickness ≥ 19 mm (3/4")

Board maximum size 3000 x 1250 mm (118,11" x 49,21")

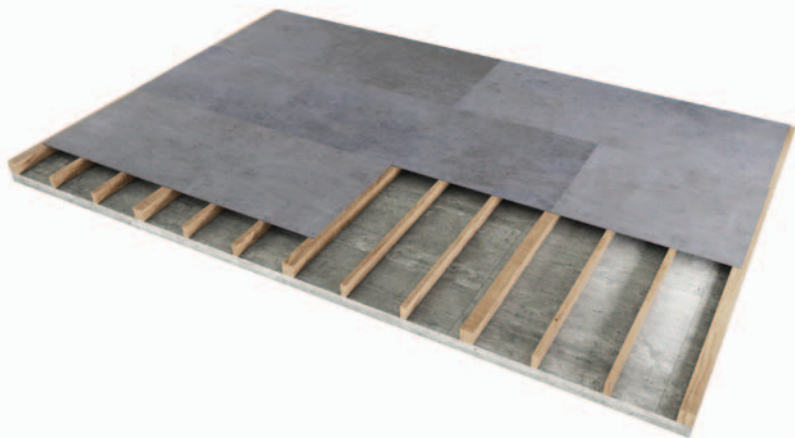

PT

A fixação dos painéis Viroc poderá ser realizada por parafusos ou colagem à estrutura.

EN

The Viroc panels fastening should be done by screws or gluing to the structure.

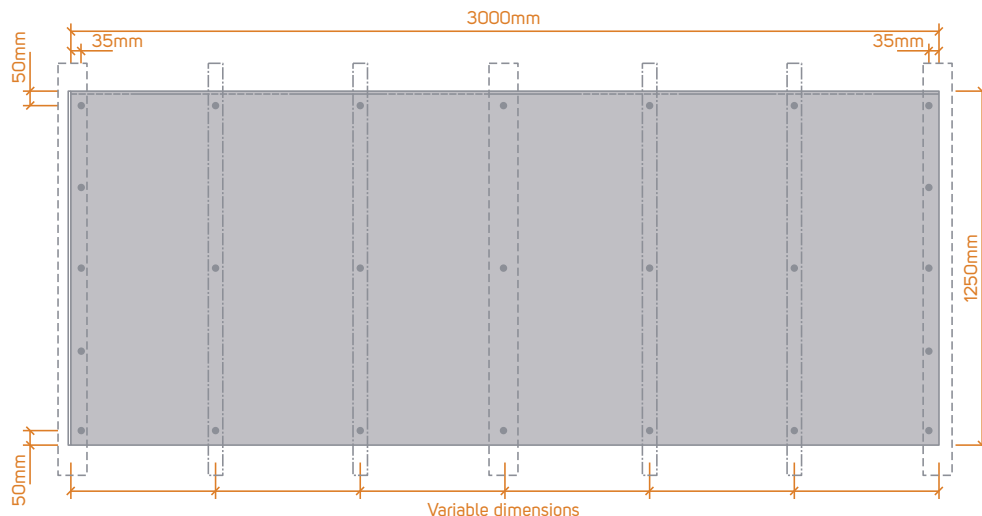

Localização das fixações do painel
Location of the panel fastenings

PT

Parafuso para estrutura metálica

EN

Screws for metal structure

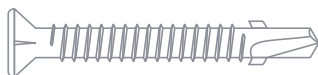

PT

Parafuso para estrutura de madeira

EN

Screws for wood structure

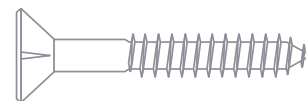

PAVIMENTOS | FLOORING

SOBREELEVADO | RAISED FLOORING

PT

Aplicação interiores

Estrutura de suporte suportes em pvc ou metálicos

Espessura bruto: ≥ 25 mm; lixado: ≥ 24 mm

Tamanho máximo do painel 600 x 600 mm

EN

Application indoors

Support structure high-density PVC supports

Thickness raw: ≥ 25 mm (1"); sanded: ≥ 24 mm (15/16")

Board maximum size 600 x 600 mm (23,62" x 23,62")

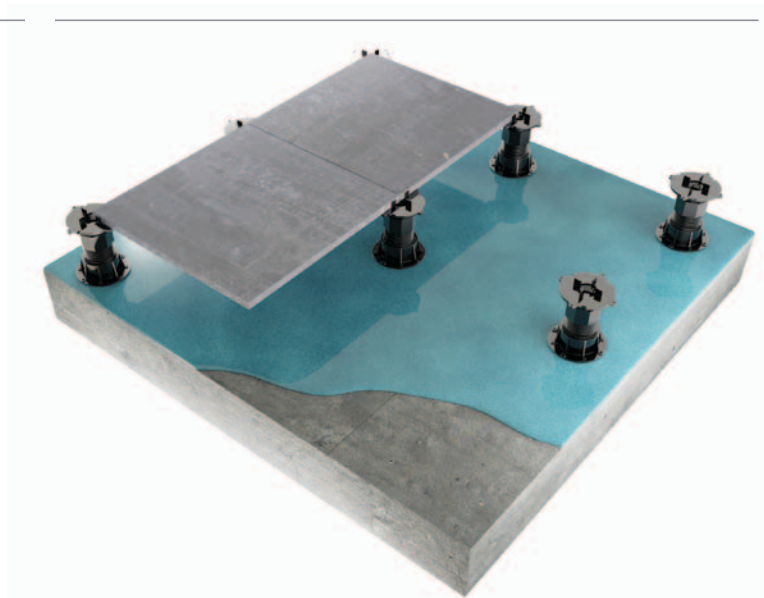

PT

Os pavimentos sobreelevados são constituídos por peças quadradas de painel Viroc assentes nas esquinas em suportes que podem ser de pvc ou metálicos.

EN

Raised floors are made up of square Viroc panel pieces set in the corners on supports that can be PVC or metallic.

Exemplo de pé de suporte em pvc
Example of PVC support foot

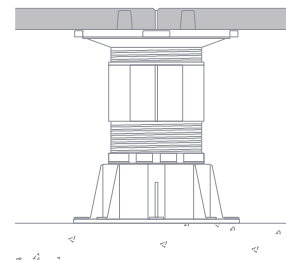

PAVIMENTOS | FLOORING

REVESTIMENTO DO PAVIMENTO | VIROC FLOOR PANELS

PT

Aplicação interiores

Estrutura de suporte pavimento novo ou existente

Fixação colagem com argamassa elástica de poliuretano

Espessura ≥ 12 mm

Dimensão máxima do painel 3000x1250 mm

EN

Application indoors

Underlying structure new or existing floor

Laying set with elastic polyurethane mortar

Thickness ≥ 12 mm (1/2")

Board maximum size 3000x1250 mm (118,1" x 49,2")

PAREDES DIVISÓRIAS E REVESTIMENTOS INTERIORES | PARTITION WALLS AND WALLS CLADDING

Grey Viroc partition walls | SRarq | Lara Seixo Rodrigues and Pedro Seixo Rodrigues | Estúdio de Fotografia | Beato, Portugal

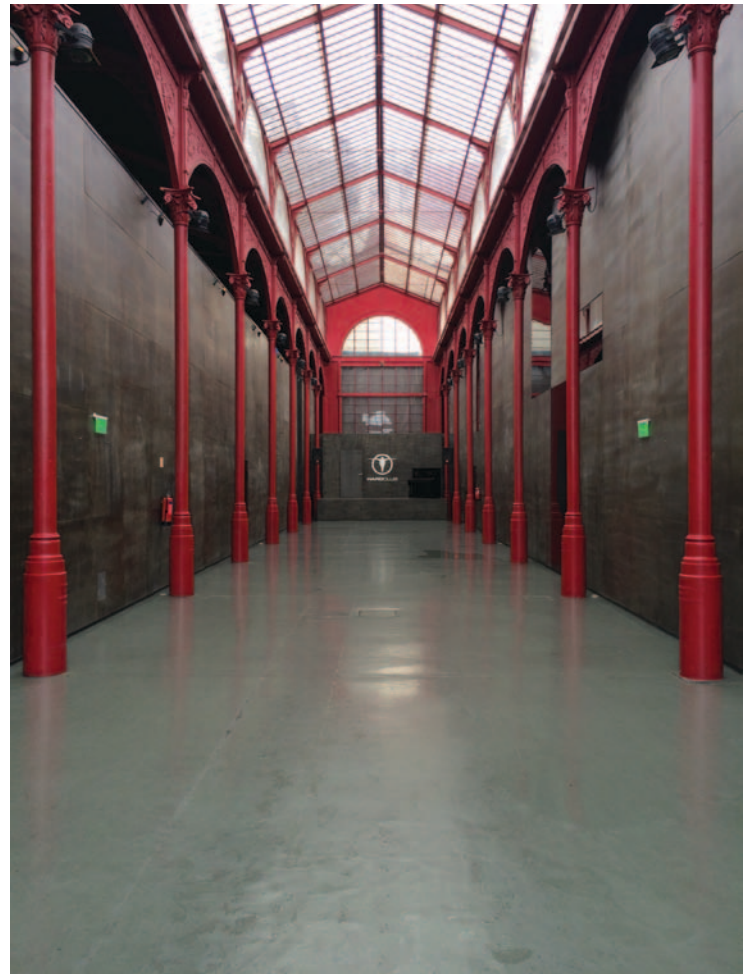

Grey Viroc walls cladding and partition walls | Mercado Ferreira Borges | Porto, Portugal

PT

Aplicação interiores**Estrutura de suporte** madeira ou metal**Fixação** parafusos, rebites, pregos ou sistema de colagem**Espessura** 10 mm para interiores secos, 12 mm para interiores húmidos e exteriores**Tamanho máximo do painel** 3000x1250 mm

Nota: disponível sob pedido para paredes acústicas e resistentes ao fogo.

EN

Application indoors**Support structure** wood or metal**Fastening** screws, rivets, nails or bonding system**Thickness** 10 mm (3/8") for indoors
12 mm (1/2") for humid environments or outdoors**Board maximum size** 3000x1250 mm
(118,11" x 49,21")

Note: available on request for acoustic and fire resistant walls.

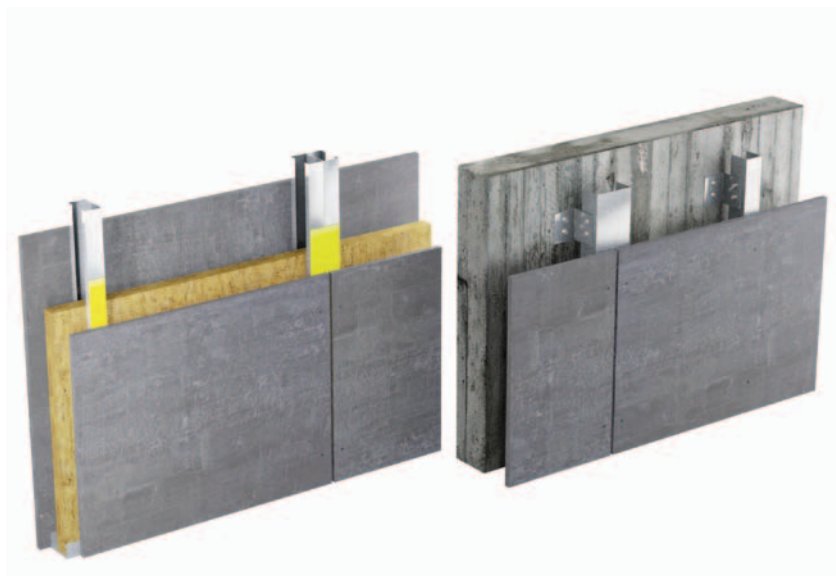

PT

Parafuso para estrutura metálica

EN

Screw for metal structure

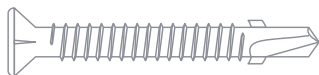

PT

Parafuso para estrutura de madeira

EN

Screw for wood structure

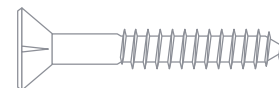

PT

Isolamento sonoro:

A Viroc dispõe de sistemas de paredes divisórias testadas com índice de redução sonora (Rw) de 47 a 65 dB.

Resistência ao fogo:

A Viroc dispõe de paredes divisórias testadas com resistência ao fogo, de EI30 a EI120 de acordo com a EN 13501-2.

EN

Sound insulation:

Viroc has partition wall systems tested with sound reduction index (Rw) of 47 to 65 dB.

Fire resistance:

Viroc has partition wall systems tested with fire resistance, from EI30 to EI120 according to EN 13501-2.

TECTOS | CEILINGS



Grey Viroc suspended ceilings | Escola Barrio de la Paz | Estructuras Aragón | Zaragoza, Spain

PT

Aplicação interiores e exteriores**Estrutura de suporte** metal**Fixação** parafusos, rebites**Espessuras** 10 mm para interiores secos,

12 mm para interiores húmidos e exteriores

Tamanho máximo do painel 3000x1250 mm

EN

Application indoors and outdoors**Support structure** metal**Fastening** screws / rivets**Thickness** 10 mm (3/8") for indoors

12 mm (1/2") for humid environments or outdoors

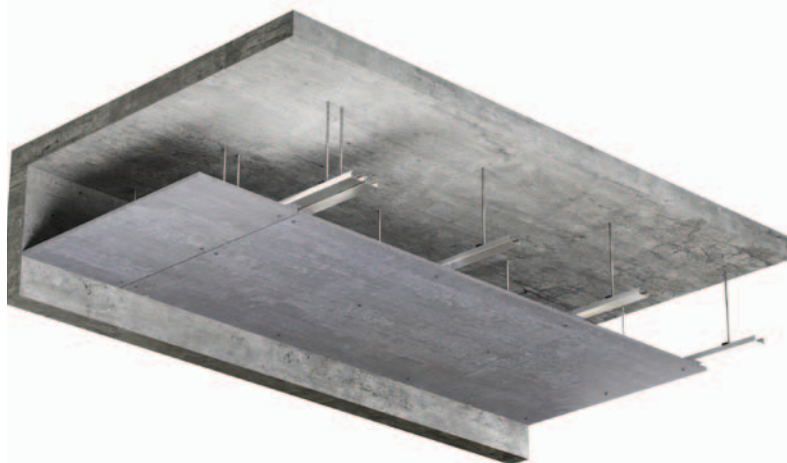
Board maximum size 3000x 250 mm (118,11" x 49,21")

PT

A fixação dos painéis à estrutura de suporte será realizada através de parafusos ou rebites de cabeça larga.

EN

The fastening of the panels to the support structure will be carried out by screws or wide head rivets.

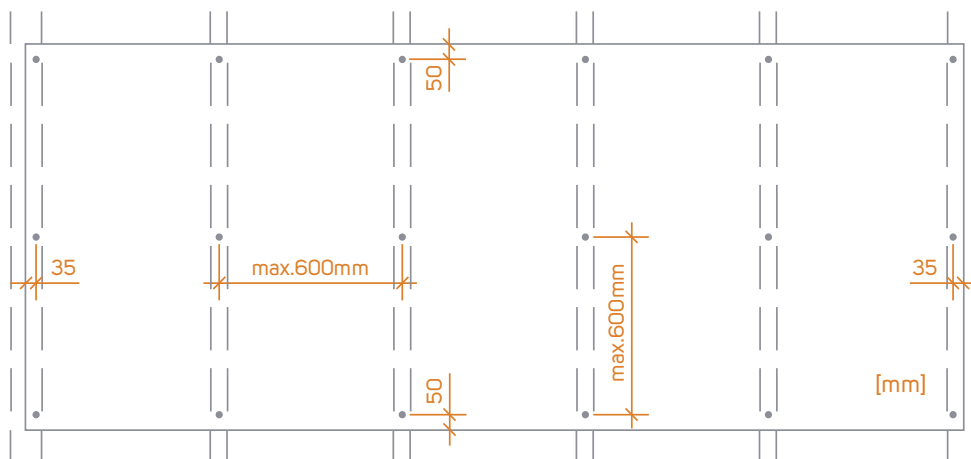

Localização das fixações do painel
Location of the panel fastenings

PT

Rebites

EN

Rivets

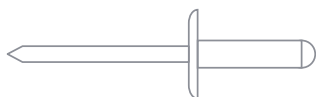

PT

Parafusos

EN

Screws

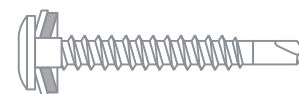

PT

Perfil de suporte, 1mm de espessura

EN

Support profile, 1mm thickness

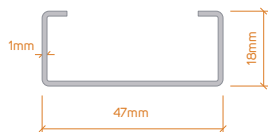

PT

Pormenor de pivot de suporte

EN

Detail of support pivot

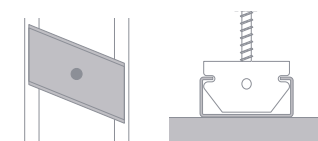

MOBILIÁRIO | FURNITURE
URBANO | URBAN



Grey Viroc exterior furniture | Arq. Ana Guerra | Lisbon, Portugal

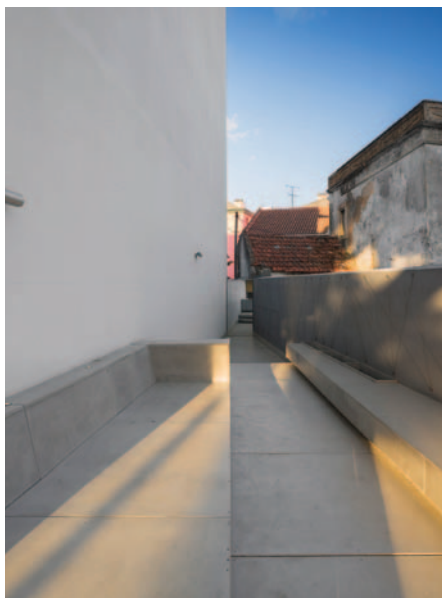
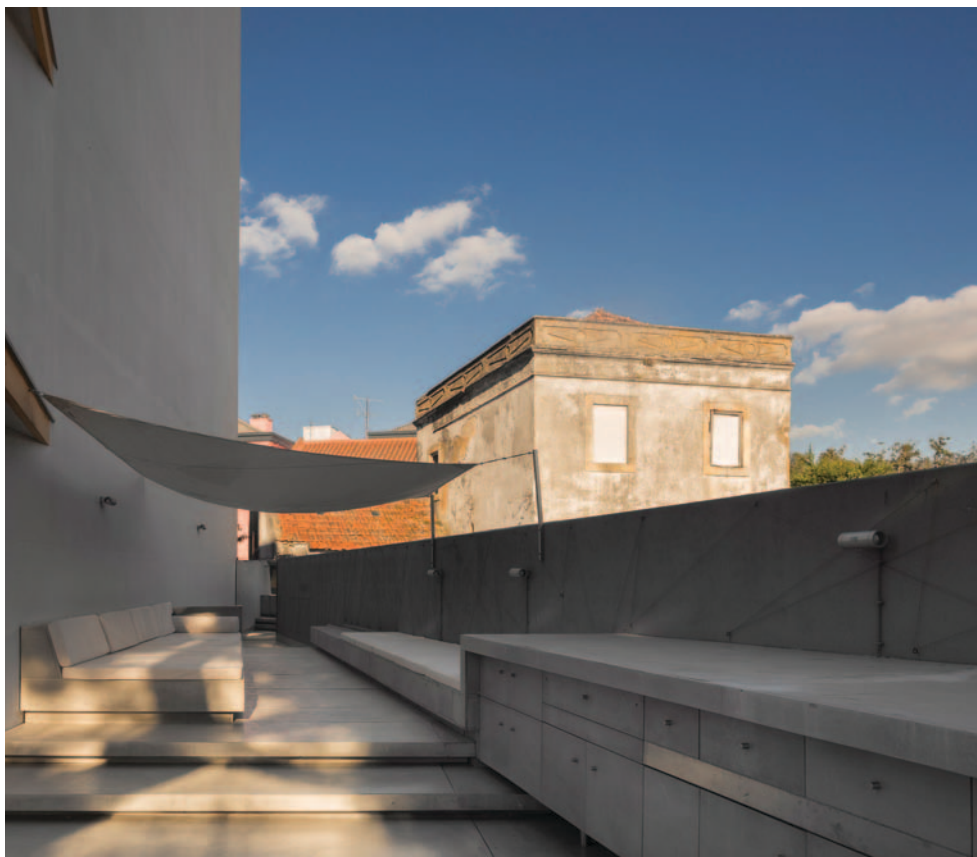

MOBILIÁRIO | FURNITURE
INTERIOR | INDOOR



Grey Viroc interior design | PopUp House | France



Grey Viroc interior furniture | Ymedia office | BARRONKRESS SL Cristina Barrón y Benjamin Kress | Madrid, Spain

ESPESSURAS POR APLICAÇÃO | THICKNESS BY APPLICATION

Aplicação Application	Espessura Thickness									
	mm	8	10	12	16	19	22	25	28	32
	Inch	0.315	0.394	0.472	0.630	0.748	0.866	0.984	1.102	1.260
Fachadas ventiladas Ventilated facades				•	•					
Paredes divisórias Partition walls			•	•						
Revestimentos interiores Interior wall cladding			•	•						
Tectos falsos False ceilings		•	•	•						
Pavimentos Flooring						•	•	•	•	•
Pavimentos técnicos Technical Flooring								•	•	•
Design interiores/Mobiliário Interior Design/Furniture	•	•	•	•	•	•	•	•	•	•

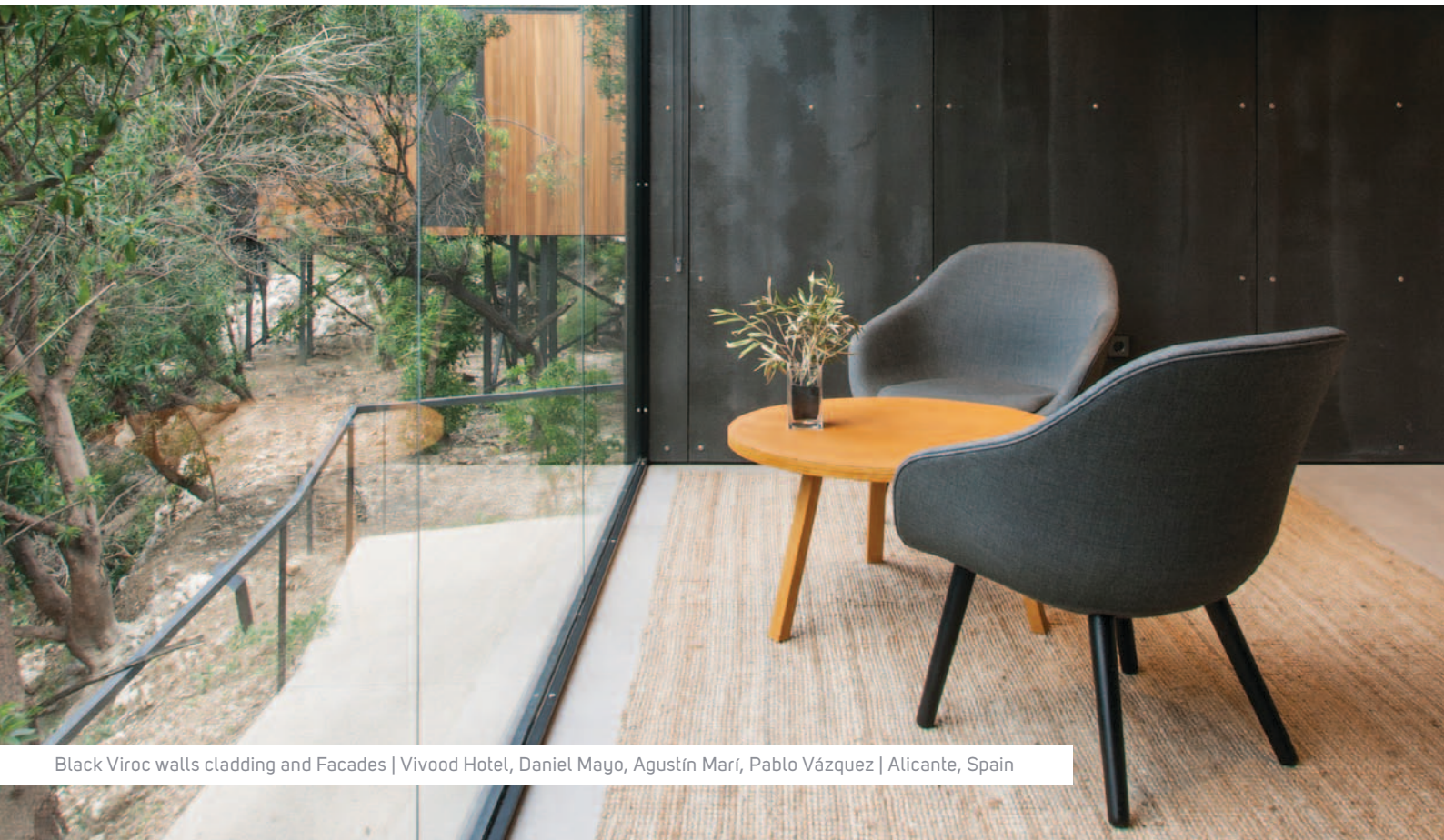

Black Viroc walls cladding and Facades | Vivood Hotel, Daniel Mayo, Agustín Marí, Pablo Vázquez | Alicante, Spain

ACABAMENTOS | FINISHING

MAQUINAÇÃO | MACHINING

PT

Corte

O painel Viroc pode ser maquinado tal como a madeira. Para espessuras até 19 mm pode ser utilizada uma serra portátil. Para espessuras maiores ou grandes volumes de corte deve ser utilizada uma serra fixa de bancada, pois permite uma melhor qualidade de superfície e uma aplicação mais fácil dos requisitos de higiene e segurança. Os dentes do disco da serra devem ser alternados ou trapezoidais e com pastilhas de tungsténio para cortar madeira ou alumínio. Para cortes curvos poderá ser utilizada uma serra tico-tico, nestes casos, devem ser utilizadas lâminas para madeira ou metal.

Furação

Os furos poderão ser realizados com um berbequim convencional sem percussão, utilizando brocas para perfurar metal.

Lixagem

O painel Viroc pode ser fornecido calibrado/lixado. Uma vez lixado, apresenta partículas de madeira visíveis na superfície do painel. A tolerância de espessura no painel lixado é de $\pm 0,3$ mm. Podem ser utilizadas máquinas de disco vibratórias ou de banda.

Maquinação das arestas

As arestas do painel podem ser maquinadas em forma de bisel com uma tupa. As arestas poderão ser entalhadas com macho-fêmea ou meia madeira.

EN

Cutting

The Viroc board may be machined just like wood. A portable circular saw can be used for thicknesses up to 19 mm. A workbench saw should be used for greater thicknesses or large cutting volumes, as it permits better surface quality and easier implementation of hygiene and safety requirements. The teeth of the saw blade must be alternated or trapezoidal, with tungsten inserts for cutting wood or aluminum. For curved cuts a jigsaw may be used, in these cases it should be used blades for wood or metal.

Drilling

Holes may be drilled in the Viroc board with a conventional hammerdrill using drill bits suitable for drilling metal, and without percussion.

Sanding

The Viroc board can be supplied calibrated/sanded. When the board is sanded, wood particles become visible on the board surface. The thickness tolerance of the sanded board is ± 0.3 mm. Vibratory disk or belt sanders can be used.

Machining of edges

The edges of the panel can be machined into a bevel with a router. The edges can be machined with male-female or half-lap joints.

ACABAMENTOS | FINISHING REVESTIMENTOS | COATINGS

PT

Verniz

O painel Viroc poderá ser envernizado, melhorando a sua proteção.

A Viroc recomenda o envernizamento ou pintura do painel em todas as aplicações exteriores.

Recomendações de envernizamento

O verniz sela o painel protegendo-o das variações atmosféricas como a exposição solar, exposição da chuva e variação de temperatura, minimizando as variações dimensionais.

Antes de aplicar o verniz, as superfícies têm de estar secas e limpas de gorduras, pó ou sais. Podem ser limpas através de um polimento com discos de limpeza ou, na sua ausência, através de uma lixa de papel fina de grão igual ou superior a 180.

A primeira demão tem de ser aplicada em ambas as faces e em todos os bordos. As demãos seguintes só necessitam de ser aplicadas na face visível e nos bordos.

A Viroc poderá recomendar os vernizes adequados para aplicar sobre os painéis.

Pintura

O painel Viroc poderá ser pintado para efeitos decorativos.

A Viroc recomenda o envernizamento ou pintura do painel em todas as aplicações exteriores

Recomendações de pintura

Antes de serem pintadas, as superfícies têm de estar secas e limpas de gorduras, pó ou sais. Podem ser limpas através de um polimento com discos de limpeza ou, na sua ausência, através de uma lixa de papel fina de grão igual ou superior a 180.

A primeira demão tem de ser aplicada em ambas as faces e em todos os bordos. As demãos seguintes só necessitam de ser aplicadas na face visível e nos bordos.

A Viroc poderá recomendar as tintas adequadas à pintura dos painéis.

Informações adicionais

Sem o painel devidamente selado, com os ciclos de molhagem, poderão surgir à superfície sais constituintes do cimento, formando manchas brancas. Essas manchas poderão ser limpas com a realização de um polimento com disco de limpeza, mas nem sempre desaparecem por completo.

As variações dimensionais terão amplitudes maiores. O encolhimento do painel poderá ser de 5mm/m (0.5%), as fixações junto aos bordos terão de possibilitar estas variações de dimensões sem introdução de esforços.

Não estando selado, o painel poderá empenar para fora do plano.

Para dimensões superiores às indicadas, consultar a Viroc Portugal.

Para mais informação sobre os painéis Viroc, por favor consulte a Viroc Portugal e o Dossier Técnico de Aplicação.

A Viroc Portugal não se responsabiliza pelas aplicações dos seus clientes, pois não pode garantir que as mesmas seguirem as recomendações técnicas disponibilizadas pela empresa.

EN**Varnish**

The Viroc panel can be varnished, improving its protection. Viroc recommends varnishing or panel painting in all exterior applications.

Varnishing recommendations

The varnish seals the panel protecting it from the atmospheric variations such as sunlight exposure, rain and temperature variation minimizing the dimensional variations.

Prior to applying any coating, the surface of the board should be completely dry, clean and free of salts, oils or fats.

These can be cleaned through a polishing with cleaning discs or in its absence through fine grain sandpaper equal or superior to 180.

The first coat must be applied on both sides and all edges. The following coats only need to be applied to the visible face and to the edges.

Viroc may recommend suitable varnishes to apply to the panels.

Painting

The Viroc panel can be painted for decorative purposes. Viroc recommends varnishing or panel painting in all exterior applications.

Painting recommendations

Before applying paint, the panel surfaces must be completely clean and dry, free from grease, dust or surface salts.

The surface should be cleaned by polishing with a cleaning disc or sanding with very fine sandpaper.

The first coat must be applied on both sides and all edges. The following coats only need to be applied to the visible face and to the edges.

Viroc may recommend suitable paints to apply to the panels.

Additional Information

Without the panel properly sealed, due to the wetting cycles, there may appear to the surface constituents of the cement, forming white stains. These stains can be cleaned with a polishing cleaning disc but not always disappear completely.

The dimensional variations will have larger amplitudes.

The shrinkage of the panel may be 5mm / m (0.5%), the anchorages near the edges will have to allow these variations of dimensions without the introduction of forces.

If the panel isn't sealed, it may bend out of the plan.

For dimensions above those indicated, consult Viroc Portugal.

For more information on Viroc panels, please consult Viroc Portugal and the Technical Application Dossier.



Grey Viroc interior furniture | Private Home | DIESEL Architects | Amsterdam, Netherlands

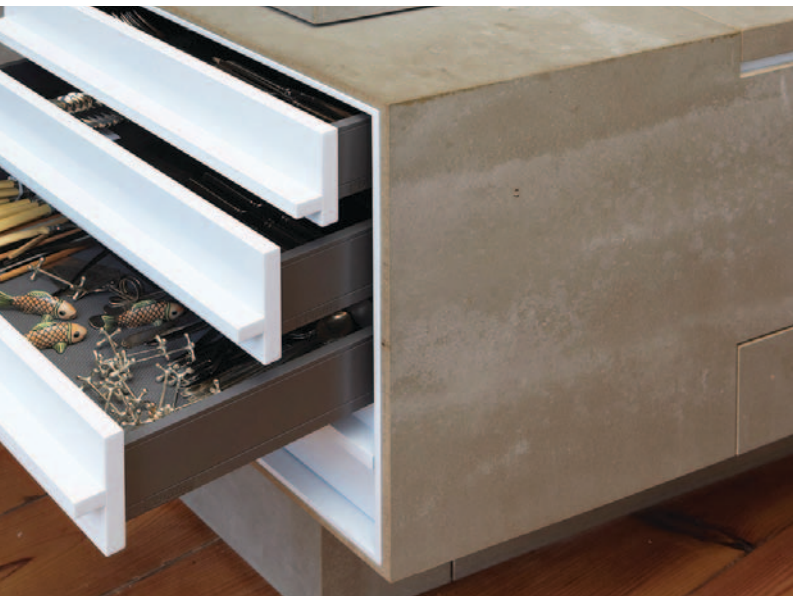



Cine Elma | Arq. Hildegard Glez-Cebrián F. de Cateya and Arq. Jan Liebe | Spain



